

TABLE OF CONTENTS

WW-SSCB06 (replaces SA101N16J-NL)

PAN-STEEL® System Overview

PAN-STEEL® System	A1-A6
<i>PAN-STEEL® System for Extreme Applications Overview</i>	A2-A6

PAN-STEEL® Self-Locking Stainless Steel Cable Ties (MLT Series)

PAN-STEEL® Self-Locking Stainless Steel Cable Ties (MLT Series)	B1-B10
<i>PAN-STEEL® Self-Locking Stainless Steel Cable Ties Overview</i>	B2-B3
Enhanced <i>PAN-STEEL® Self-Locking Stainless Steel Cable Ties – MLT Series</i>	B4-B5
Enhanced <i>PAN-STEEL® WAVE-TY™ Superior Grip Stainless Steel Ties</i>	B6
Custom Length Banding System MBS, MBH, MBEH and MBSH Banding	B7
MTHS, MTHH, MTHEH and MTHSH Banding Heads	B8
Enhanced Patented Nylon 11 Selectively Coated Ties – MLTC Series	B9
Fully Coated Ties	B9
PCS Cushion Sleeve	B10

PAN-STEEL® Double Wrapped Stainless Steel Cable Ties	B11-B14
<i>PAN-STEEL® Double Wrapped Stainless Steel Cable Ties – MLTDH Series</i>	B11
PPTMT Installation Tool	B12
GS4MT Installation Tool	B13
Tool Tension Lock Kit	B13
ST3MT Installation Tool	B14
RT1HT Installation Tool	B14
HTMT Installation Tool	B14

PAN-STEEL® Stainless Steel Strapping (MS Series)

PAN-STEEL® Stainless Steel Strapping (MS Series)	C1-C7
<i>PANDUIT® PAN-STEEL® Stainless Steel Strapping System Overview</i>	C2-C3
<i>PAN-STEEL® Stainless Steel Strapping</i>	C4
Custom Length Strapping	C5
Buckles for Custom Length Strapping	C5
<i>PAN-STEEL® Nylon Coated Stainless Steel Strapping</i>	C6
BT1HT Installation Tool	C6
BT2MS75 Installation Tool	C7

PAN-STEEL® System for Permanent Marking and Identification

PAN-STEEL® System for Permanent Marking and Identification	D1-D2
Stainless Steel, Brass and Aluminum Marker Plates and Tags	D2
PAN-STEEL® Custom Marking Capabilities Overview	D3-D5
Metal Embossing Tape System	D4
Indenter Press	D4
Marker Stamp Kit	D5
KP-515 Design Kit	D5

PAN-STEEL® System Accessories

PAN-STEEL® System Accessories	E1-E4
MTM1H Stainless Steel Tie Mount	E2
Stainless Steel Push Mount	E2
Stainless Steel Push Button Mount	E2
Stainless Steel 2-Way Mount	E3
Stainless Steel Bulkhead Mount	E3
Stackable Aerial Cable Spacer	E4

Stainless Steel Technical Information

Stainless Steel Tie Technical Information	F1-F3
Physical Characteristics of Stainless Steel Cable Ties – MLT Series	F1
<i>PANDUIT® Stainless Steel Cable Tie and Strapping Approvals</i>	F1
Approvals	F1
Chemical Resistance at 70° F (21°C) Temperature	F2
Rigorous Tests and Physical Properties of Stainless Steel Ties	F2-F3
Military Cross Reference	F3
Gage Conversion Chart	F3

Index

Index	G1-G3
--------------------	--------------

PANDUIT® PAN-STEEL® System FOR HARSH ENVIRONMENTS

PAN-STEEL® System for Harsh Environments

**PANDUIT® PAN-STEEL®
Stainless Steel Ties are engineered
to outlast the toughest corrosive
and environmental extremes.**

Now a revolutionary new locking head design makes them the highest rated loop tensile strength, tightest clamping, easiest threading ball locking ties in the world.

The increased performance of the PAN-STEEL® System provides an extra margin of safety and lower installed cost.

- Withstands harsh environments
- Unique locking ramp
- Self-locking with low thread force
- Fully rounded edges
- Type 304 and 316 stainless steel
- State-of-the-art tooling

Nylon 11 Coated Ties

Wave-Ty™ Stainless Steel Ties

General Purpose Ties

**PANDUIT® is a Global Leader
Providing Innovative Wire
Management Solutions.**

- **Stainless Steel Systems**
- **Cable Ties and Accessories**
- **Raceway Systems**
- **Routing Systems**
- **Identification Systems**
- **Power and Grounding Systems**
- **Terminals**
- **Safety and Facility Solutions**

A Revolutionary New Design in Stainless Steel Ties

Self-Locking Head Construction

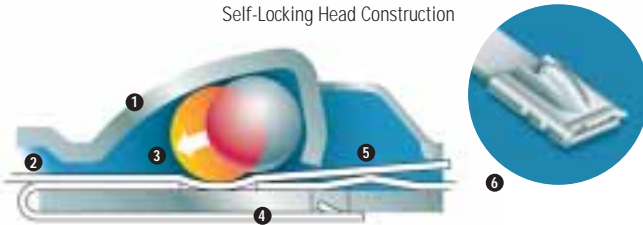

- | | |
|--|--|
| <p>1 New aggressive locking head*
Quicker locking, tighter installation</p> <p>2 Exclusive lead in design*
Wider entrance for easier threading</p> <p>3 Innovative displacement lock*
Assures superior locking strength</p> | <p>4 Extended retaining tab
Increases overall tie strength</p> <p>5 Unique locking ramp
Assures locking in any position</p> <p>6 Strengthening ribs**
Stronger head increases lock strength</p> |
|--|--|

* Patented

** Patent Pending



Military Specification
MIL-S-23190E



ABS Programs
Cert. 99CH18282-X



Bureau Veritas



Det Norske Veritas



Lloyd's Register
of Shipping



Markets

MLT Ties

MS
Strapping

Marking
and
ID

Accessories

Technical
Info

Index

PAN-STEEL® System

The *PAN-STEEL*® System provides a strong, durable method of bundling, identifying and fastening, which can be used in virtually all indoor, outdoor and underground (including direct burial) applications, where severe environmental conditions exist. The ties are designed for use in critical applications where strength, vibration, radiation, weathering, corrosion and temperature extremes are a factor.



- High strength
- Long life
- Weather resistant
- Chemical resistant
- Temperature extremes
- Radiation resistant
- Permanent identification

PANDUIT® offers unique products to meet customer needs:

Metal Locking Ties — Excellent performance in any environment

Nylon 11 Selectively Coated Ties — Strength of steel, protection of nylon

WAVE-TY™ Stainless Steel Ties — Maintains a high tension grip on non-resilient objects

Fully Coated Ties — Polyester coated for additional bundle protection

Strapping — Reduces installation time and leaves no sharp edges

Mounts and accessories — Used with *PAN-STEEL*® ties and straps to speed and simplify mounting

Permanent identification products — Custom identification for harsh environments

State-of-the-art tooling — Speed installation and lower installed cost

Markets

MLT Ties

MS
Strapping

Marking
and
ID

Accessories

Technical
Info

Index

PANDUIT® PAN-STEEL® Applications



AIRCRAFT

PANDUIT® PAN-STEEL® Stainless Steel Ties (type MLT) are used to fasten thermal insulation blankets to jet engine manifolds and tubes.

PRIMARY BENEFIT

Installation tooling with controlled tension and auto cut-off capability significantly reduces cost of installation. The low weight, high strength of the ties makes them more efficient and reliable than conventional fasteners. The stainless steel ties have been temperature tested to over 1000° F (538°C) to provide excellent continuous service over the entire temperature range and to provide long life.



AIRCRAFT

PANDUIT® PAN-STEEL® Stainless Steel Ties are used to secure insulation envelopes to ducting in aircraft fuselages.

PRIMARY BENEFIT

The ties have been tested to over 1000° F (538°C) which provides excellent continuous service over the entire operating range. The single wrap, self-locking low weight design provides improved efficiency and reliability.



TRUCK ENGINES

PANDUIT® PAN-STEEL® Stainless Steel Ties are used to fasten thermal insulation blankets to truck engine exhaust pipes.

PRIMARY BENEFIT

The ties provide high strength, low profile and low weight design, which are more efficient than conventional fasteners. The ties are temperature tested to over 1000° F (538°C) for performance under continuous high temperature conditions.



AUTOMOTIVE

PANDUIT® PAN-STEEL® Stainless Steel Ties are used to fasten constant velocity (CV) boots on front wheel drive automobiles.

PRIMARY BENEFIT

The ties can be installed without disassembling the constant velocity (CV) joint which saves installation time and lowers installed costs. The stainless steel ties provide excellent weather resistance and corrosion resistance for long life with high strength and low weight.



AUTOMOTIVE

PANDUIT® PAN-STEEL® WAVE-TY™ Stainless Steel Ties and the PPTMT Pneumatic Installation Tool are used to fasten heat shields on automotive exhaust assemblies.

PRIMARY BENEFIT

Pneumatic installation tooling with controlled tension and automatic cut-off capability speeds installation time and lowers installed costs. WAVE-TY™ Stainless Steel Ties retain tension on a solid bundle where other stainless steel ties will not function.

PANDUIT® PAN-STEEL® Applications (continued)



TELECOMMUNICATIONS

PANDUIT® PAN-STEEL® Stainless Steel Ties are used to securely fasten cables to telecommunication towers.

PRIMARY BENEFIT

The ties provide long life, corrosion and chemical resistance in outdoor harsh environments and temperature extremes. The self-locking design provides fast and easy installation. State-of-the-art tooling further reduces installation time.

MLT Ties



MAINTENANCE AND REPAIR (MRO)

PANDUIT® PAN-STEEL® Stainless Steel Ties are used to fasten pipe markers in pulp and paper mills, refineries, power plants and breweries.

PRIMARY BENEFIT

The ties provide extended service life, which reduces the need for periodic rework. The single wrap self-locking design provides fast and easy installation. The ties provide excellent chemical resistance in harsh environments and in high temperature extremes.

MS Strapping



MAINTENANCE AND REPAIR (MRO)

PANDUIT® Custom Marked Marker Plates attached with PAN-STEEL® Stainless Steel Ties are used to identify conduit and circuits in petrochemical plants, pulp and paper mills, refineries, and breweries.

PRIMARY BENEFIT

The products are marked to meet customer specifications with one of two computer controlled systems (laser or embosser), which provides permanent identification to resist corrosion, abrasion, and radiation in harsh environments.

Marking and ID



PETROCHEMICAL PROCESSING

PANDUIT® PAN-STEEL® Stainless Steel Ties, Strapping and Marker Plates are used in chemical plants to bundle cables to cable trays and to identify conduit and cables.

PRIMARY BENEFIT

The ties provide long life, corrosion resistance and high temperature extremes and allow the ties to be used in many different applications.

Accessories



NUCLEAR PLANTS

PANDUIT® PAN-STEEL® Stainless Steel Ties are used to secure heat trace cable and replace wing seal strapping methods. A complete selection of state-of-the-art tooling makes installation quicker and easier and reduces the amount of exposure time for plant maintenance personnel in containment areas.

PRIMARY BENEFIT

The ties have high radiation resistance (2X10⁸ RAD) for excellent use in containment areas.

Technical Info

Index

PANDUIT® PAN-STEEL® Applications (continued)



TRAFFIC SIGNALS

PANDUIT® PAN-STEEL® Stainless Steel Ties are used for bundling and fastening cables to messenger strand in traffic signal applications.

PRIMARY BENEFIT

The ties provide a 40 year service life, which reduces the need for periodic rework. The smooth fully radiused sides are safe to use and will not injure installer's hands or abrade cable insulation.



AERIAL SUPPORT

PANDUIT® PAN-STEEL® Stainless Steel Ties are used to fasten cable and/or splice closures to the messenger strand in aerial support applications.

PRIMARY BENEFIT

The ties provide a 40 year service life, which reduces the need for periodic rework. The ties are unaffected by sun, acid rain, or most chemicals, which allows them to be used in many different environments.



OFFSHORE OIL

PANDUIT® PAN-STEEL® 316 Grade Stainless Steel Cable Ties, Straps, and Nylon 11 Selectively Coated Ties are used to fasten cables and hoses on offshore platforms.

PRIMARY BENEFIT

The ties provide superior corrosion protection in salt spray environments, which extends service life and reduces need for periodic rework.



SHIPBUILDING

PANDUIT® PAN-STEEL® Stainless Steel Cable Ties are used to fasten cables to cable trays and cable hangers in shipbuilding applications.

PRIMARY BENEFIT

The ties provide extended service life, which reduces the need for periodic rework; are non-flammable so no toxic or harmful gases are released in case of fire; and have fully rounded sides, which are safe to use and will not injure installer's hands or abrade cable insulation.



RAILROAD

PANDUIT® PAN-STEEL® Stainless Steel Ties are used to bundle, fasten, and secure cables and hoses on trains, especially in exposed areas underneath engines and cars that are subjected to harsh environmental conditions. The ties have passed Japanese Industry Standard for salt spray (JIS-C-5028) and vibration (JIS-C-4031).

PRIMARY BENEFIT

The ties provide high strength with low weight and low profile for improved efficiency and reliability. The extended service life reduces the need for periodic rework.

STAINLESS STEEL SYSTEMS

METAL TIES

PAN-STEEL® STAINLESS STEEL TIES (MLT SERIES): Metal locking ties, ball lock version in .17" (4.4mm), .25" (6.4mm), .31" (7.9mm), .50" (12.7mm), and .63" (15.9mm) widths

CUSTOM LENGTH BANDING SYSTEM:

Provided in reels in .17" (4.4mm), .25" (6.4mm), .31" (7.9mm), .50" (12.7mm), and .63" (15.9mm) widths

METAL STRAPS

STAINLESS STEEL STRAPS (MS SERIES):

Fold-over buckle design in .38" (9.5mm), .50" (12.7mm) and .63" (15.9mm) widths

CUSTOM LENGTH STRAPPING SYSTEM:

Provided in reels in .375" (9.5mm), .50" (12.7mm) and .63" (15.9mm) widths

Markets

MLT Ties

MS
Strapping

Marking
and
ID

Accessories

Technical
Info

Index

PAN-STEEL® Self-Locking Stainless Steel Cable Ties (MLT Series)

PANDUIT® is a leading producer of stainless steel ties for harsh environments. New designs are continually introduced to meet the application challenges encountered by our customers, while providing the lowest installed cost.



- Self-locking
- Fully rounded edges
- Low thread force
- 100% Stainless Steel construction
- Patented displacement lock
- Unique locking ramp
- Patented lead-in design
- Extended retaining tab
- Patented aggressive locking head
- Patent pending strengthening ribs
- Complete line of installation tools

PANDUIT® offers unique products to meet customer needs:

General Purpose Ties — Excellent performance in any environment

WAVE-TY™ Stainless Steel Ties — Unique wave form spring maintains a high tension grip on non-resilient objects

Patented Nylon 11 Selectively Coated Ties — Strength of steel, protection of nylon

Fully Coated Ties — Polyester coated for additional bundle protection

Double Loop Ties — Tighter tensioning and higher loop tensile strength

Complete Line of Installation Tools — Manual and pneumatic installation tools for controlled tension, automatic cut-off and lower installed cost

PANDUIT® PAN-STEEL® System FOR HARSH ENVIRONMENTS

Markets

A revolutionary new design in stainless steel ties!

MLT Ties

Engineered for the most extreme applications...

- World's highest rated loop tensile strength ball locking tie for an extra margin of safety
- Aggressive head design provides higher retained tension for a more secure bundle
- Exclusive lead-in design for quick, easy threading for fastest installation time

MS Strapping

Marking and ID

Accessories

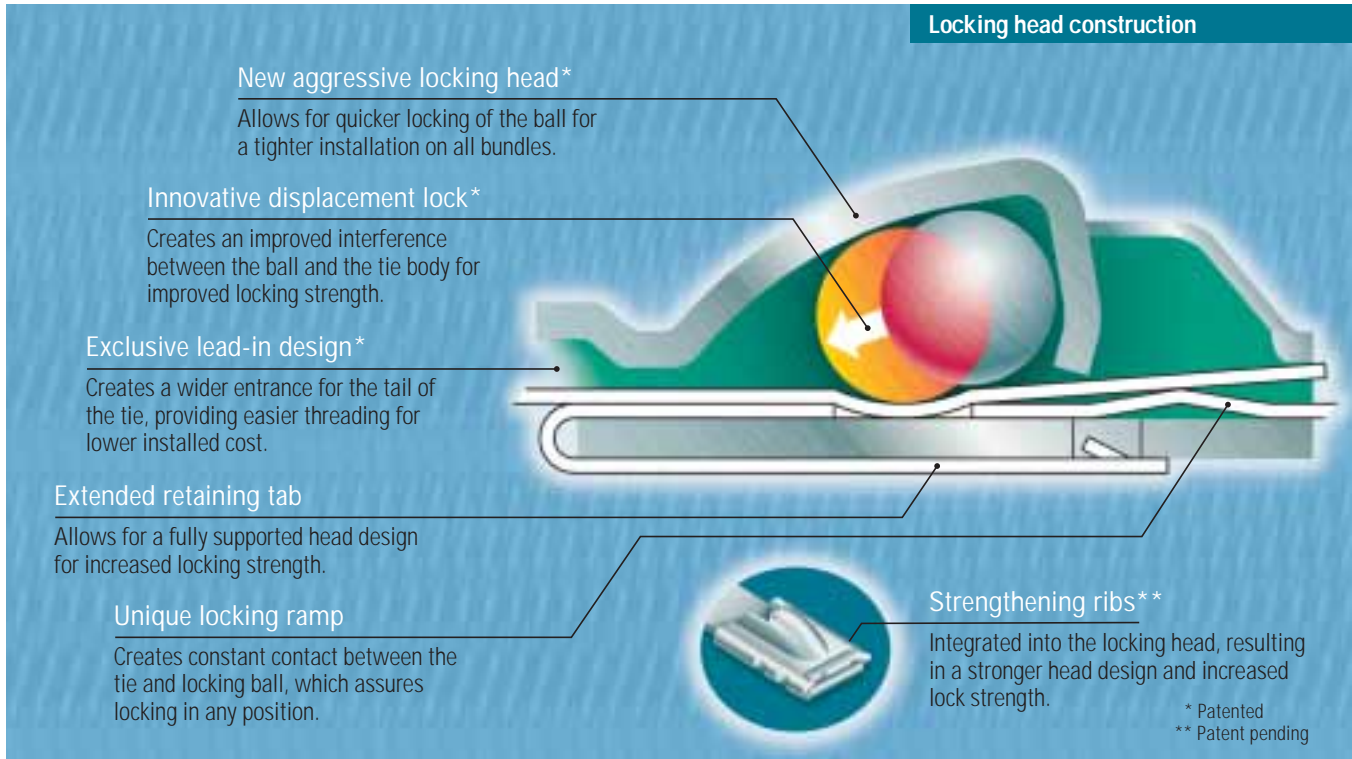

Advantages of the Rounded Side of PAN-STEEL® Stainless Steel Ties

Technical Info



Cross sectional view of other manufacturer's tie body. (Photo micrograph shown is magnified 150X).



Cross sectional view of PANDUIT® tie body. (Photo micrograph shown is magnified 150X).

Index

The PAN-STEEL® Stainless Steel Cable Tie is designed for superior comfort and safety when handling due to its fully rounded sides and smooth surfaces. Smooth surfaces and rounded sides assure cable protection and operator safety. PANDUIT® not only removes the burr, but actually passes the material through a secondary process which removes the top and bottom corners of the material.

Self-Locking Head for Fast Installation



1. Place tie around bundle, put tip through head and pull up tight by hand.



2. Use one of the PANDUIT® PAN-STEEL® installation tools to tension and cut off excess tail quickly.

The stainless steel metal locking tie series can be fastened by hand as shown in **Photo 1**. No tools are required. Just place around bundle, pull the tip of the tail through the locking head and pull up tight by hand. The self-locking head secures the tie in place.

Photo 2 shows the metal locking tie series being installed with the PANDUIT® GS4MT tool, which automatically tensions and cuts off excess tie. The system provides adjustable tension control and automatic cut-off for quick, consistent and secure installation with the lowest installed cost.

Part Number System Example – MLT Series

(Stock Size Tie)

MLT	6	S	–	CP	
Part Description	Bundle Diameter Reference (Inches)	Cross-Section S = Standard LH = Light Heavy H = Heavy EH = Extra Heavy SH = Super Heavy		Package Qty. Q = 25 L* = 50 LP** = 50 CP = 100 *Standard Cross-Section **Heavy Cross-Section	Material (blank) = 304 316 = 316

PAN-STEEL® Stainless Steel Ties – MLT Series



Enhanced PAN-STEEL® Self-Locking Stainless Steel Cable Ties



- Strong, durable method of bundling and fastening
- Can be used in virtually all indoor, outdoor and underground (including direct burial) applications
- Well suited for network bundling of data and power cables
- Fully rounded edges and exclusive lead-in design
- Provides ultimate support for network cables
- Available in 316 material for the most corrosive environments

Part Number	Max. Bundle Diameter		Length**		Min. Loop Tensile Strength*		Min. Bundle Diameter		Width		Thickness		Recommended PANDUIT® Installation Tool***	Std. Pkg. Qty.	Std. Ctn. Qty.
	In.	mm	In.	mm	Lbs.	N	In.	mm	In.	mm	In.	mm			

AISI 304 Stainless Steel – For General Purpose

Standard Cross Section

MLT1S-CP	1.0	25	5.0	127	200	890	.50	12.7	.18	4.6	.010	.25	GS4MT, HTMT, PPTMT, ST2MT or ST3MT	100	500
MLT2S-CP	2.0	51	7.9	201	200	890	.50	12.7	.18	4.6	.010	.25		100	500
MLT2S-L	2.0	51	7.9	201	200	890	.50	12.7	.18	4.6	.010	.25		50	500
MLT2.7S-CP	2.7	69	10.2	259	200	890	.50	12.7	.18	4.6	.010	.25		100	500
MLT4S-CP	4.0	102	14.3	362	200	890	.50	12.7	.18	4.6	.010	.25		100	500
MLT4S-L	4.0	102	14.3	362	200	890	.50	12.7	.18	4.6	.010	.25		50	500
MLT6S-CP	6.0	152	20.5	521	200	890	.50	12.7	.18	4.6	.010	.25		100	500
MLT8S-CP	8.0	203	26.8	679	200	890	.50	12.7	.18	4.6	.010	.25		100	500
MLT10S-CP	10.0	254	33.0	838	200	890	.50	12.7	.18	4.6	.010	.25		100	500
MLT12S-Q	12.0	304	39.3	998	200	890	.50	12.7	.18	4.6	.010	.25		25	125
MLT14S-Q	14.0	355	45.5	1156	200	890	.50	12.7	.18	4.6	.010	.25		25	125
MLT15S-Q	15.0	380	49.2	1250	200	890	.50	12.7	.18	4.6	.010	.25		25	125

NEW! Light-Heavy Cross Section

MLT2LH-LP	2.0	51	7.9	201	250	1112	.50	12.7	.25	6.4	.010	.25	GS4MT, HTMT, PPTMT, ST2MT or ST3MT	50	250
MLT4LH-LP	4.0	102	14.3	362	250	1112	.50	12.7	.25	6.4	.010	.25		50	250
MLT6LH-LP	6.0	152	20.5	521	250	1112	.50	12.7	.25	6.4	.010	.25		50	250
MLT8LH-LP	8.0	203	26.8	679	250	1112	.50	12.7	.25	6.4	.010	.25		50	250

Heavy Cross Section

MLT2H-LP	2.0	51	7.9	201	450	2000	.50	12.7	.31	7.9	.010	.25	GS4MT, HTMT, PPTMT, ST2MT or ST3MT	50	250
MLT2.7H-LP	2.7	69	10.2	259	450	2000	.50	12.7	.31	7.9	.010	.25		50	250
MLT4H-LP	4.0	102	14.3	362	450	2000	.50	12.7	.31	7.9	.010	.25		50	250
MLT6H-LP	6.0	152	20.5	521	450	2000	.50	12.7	.31	7.9	.010	.25		50	250
MLT8H-LP	8.0	203	26.8	679	450	2000	.50	12.7	.31	7.9	.010	.25		50	250
MLT10H-LP	10.0	254	33.0	838	450	2000	.50	12.7	.31	7.9	.010	.25		50	250
MLT12H-Q	12.0	305	42.0	1087	450	2000	.50	12.7	.31	7.9	.010	.25		25	125
MLT14H-Q	14.0	356	47.0	1194	450	2000	.50	12.7	.31	7.9	.010	.25		25	125

NEW! Extra-Heavy Cross Section

MLT2EH-LP	2.0	51	11.8	300	600	2670	1.0	25.4	.50	12.7	.010	.25	RT1HT or ST3MT	50	250
MLT4EH-LP	4.0	102	17.1	434	600	2670	1.0	25.4	.50	12.7	.010	.25		50	250
MLT6EH-LP	6.0	152	23.4	594	600	2670	1.0	25.4	.50	12.7	.010	.25		50	250
MLT8EH-LP	8.0	203	29.7	754	600	2670	1.0	25.4	.50	12.7	.010	.25		50	250
MLT10EH-LP	10.0	254	35.9	912	600	2670	1.0	25.4	.50	12.7	.010	.25		50	250
MLT12EH-Q	12.0	305	42.2	1072	600	2670	1.0	25.4	.50	12.7	.010	.25		25	125
MLT4EH15-LP	4.0	102	17.1	434	700	3115	1.0	25.4	.50	12.7	.015	.38		50	250
MLT6EH15-LP	6.0	152	23.4	594	700	3115	1.0	25.4	.50	12.7	.015	.38		50	250
MLT8EH15-LP	8.0	203	29.7	754	700	3115	1.0	25.4	.50	12.7	.015	.38		50	250
MLT10EH15-LP	10.0	254	35.9	912	700	3115	1.0	25.4	.50	12.7	.015	.38		50	250
MLT12EH15-Q	12.0	305	42.2	1072	700	3115	1.0	25.4	.50	12.7	.015	.38		25	125

*Per SAE Standard AS23190/3 (formerly MIL). For additional details, refer to page F1.

**Other lengths available, contact customer service.

***For information on installation tools, refer to pages B12-B14.



Enhanced PAN-STEEL® Self-Locking Stainless Steel Cable Ties (continued)



MLT Ties

Part Number	Max. Bundle Diameter		Length**		Min. Loop Tensile Strength*		Min. Bundle Diameter		Width		Thickness		Recommended PANDUIT® Installation Tool***	Std. Pkg. Qty.	Std. Ctn. Qty.
	In.	mm	In.	mm	Lbs.	N	In.	mm	In.	mm	In.	mm			
NEW! Super-Heavy Cross Section															
MLT4SH-LP	4.0	102	17.1	434	900	4005	1.0	25.4	.63	15.9	.015	.38	RT1HT	50	250
MLT6SH-LP	6.0	152	23.4	594	900	4005	1.0	25.4	.63	15.9	.015	.38		50	250
MLT8SH-LP	8.0	203	29.7	754	900	4005	1.0	25.4	.63	15.9	.015	.38		50	250
MLT10SH-LP	10.0	254	35.9	912	900	4005	1.0	25.4	.63	15.9	.015	.38		50	250
MLT12SH-Q	12.0	305	42.2	1072	900	4005	1.0	25.4	.63	15.9	.015	.38		25	125
AISI 316 Stainless Steel – For Superior Corrosion Resistance															
Standard Cross Section															
MLT1S-CP316	1.0	25	5.0	127	200	890	.50	12.7	.18	4.6	.010	.25	GS4MT, HTMT, PPTMT, ST2MT or ST3MT	100	500
MLT2S-CP316	2.0	51	7.9	201	200	890	.50	12.7	.18	4.6	.010	.25		100	500
MLT4S-CP316	4.0	102	14.3	362	200	890	.50	12.7	.18	4.6	.010	.25		100	500
MLT6S-CP316	6.0	152	20.5	521	200	890	.50	12.7	.18	4.6	.010	.25		100	500
MLT8S-CP316	8.0	203	26.8	679	200	890	.50	12.7	.18	4.6	.010	.25		100	500
MLT10S-CP316	10.0	254	33.0	838	200	890	.50	12.7	.18	4.6	.010	.25		100	500
NEW! Light-Heavy Cross Section															
MLT2LH-LP316	2.0	51	7.9	201	250	1112	.50	12.7	.25	6.4	.010	.25	GS4MT, HTMT, PPTMT, ST2MT or ST3MT	50	250
MLT4LH-LP316	4.0	102	14.3	362	250	1112	.50	12.7	.25	6.4	.010	.25		50	250
MLT6LH-LP316	6.0	152	20.5	521	250	1112	.50	12.7	.25	6.4	.010	.25		50	250
MLT8LH-LP316	8.0	203	26.8	679	250	1112	.50	12.7	.25	6.4	.010	.25		50	250
Heavy Cross Section															
MLT2H-LP316	2.0	51	7.9	201	450	2000	.50	12.7	.31	7.9	.010	.25	GS4MT, HTMT, PPTMT, ST2MT or ST3MT	50	250
MLT4H-LP316	4.0	102	14.3	362	450	2000	.50	12.7	.31	7.9	.010	.25		50	250
MLT6H-LP316	6.0	152	20.5	521	450	2000	.50	12.7	.31	7.9	.010	.25		50	250
MLT8H-LP316	8.0	203	26.8	679	450	2000	.50	12.7	.31	7.9	.010	.25		50	250
MLT10H-LP316	10.0	254	33.0	838	450	2000	.50	12.7	.31	7.9	.010	.25		50	250
NEW! Extra-Heavy Cross Section															
MLT2EH-LP316	2.0	51	11.8	300	600	2670	1.0	25.4	.50	12.7	.010	.25	RT1HT or ST3MT	50	250
MLT4EH-LP316	4.0	102	17.1	434	600	2670	1.0	25.4	.50	12.7	.010	.25		50	250
MLT6EH-LP316	6.0	152	23.4	594	600	2670	1.0	25.4	.50	12.7	.010	.25		50	250
MLT8EH-LP316	8.0	203	29.7	754	600	2670	1.0	25.4	.50	12.7	.010	.25		50	250
MLT4EH15-LP316	4.0	102	17.1	434	700	3115	1.0	25.4	.50	12.7	.015	.38		50	250
MLT6EH15-LP316	6.0	152	23.4	594	700	3115	1.0	25.4	.50	12.7	.015	.38		50	250
MLT8EH15-LP316	8.0	203	29.7	754	700	3115	1.0	25.4	.50	12.7	.015	.38		50	250
MLT8EH15-LP316	8.0	203	29.7	754	700	3115	1.0	25.4	.50	12.7	.015	.38		50	250
NEW! Super-Heavy Cross Section															
MLT4SH-LP316	4.0	102	17.1	434	900	4005	1.0	25.4	.63	15.9	.015	.38	RT1HT	50	250
MLT6SH-LP316	6.0	152	23.4	594	900	4005	1.0	25.4	.63	15.9	.015	.38		50	250
MLT8SH-LP316	8.0	203	29.7	754	900	4005	1.0	25.4	.63	15.9	.015	.38		50	250

MS Strapping

Marking and ID

Accessories

Technical Info

Index

*Per SAE Standard AS23190/3 (formerly MIL). For additional details, refer to page F1.

**Other lengths available, contact customer service.

***For information on installation tools, refer to pages B12-B14.

Markets

Enhanced PAN-STEEL® WAVE-TY™ Superior Grip Stainless Steel Ties

MLT Ties



- Patented wave-form spring maintains greater installed tension on non-resilient objects
- Tightly clamps on applications where other stainless steel ties will not function
- Retains tension on a solid bundle with minimal applied force
- Available in 316 material for the most corrosive environments
- Guarantees performance in critical applications
- Self-locking with low thread force

Part Number	Max. Bundle Diameter		Length**		Min. Loop Tensile Strength*		Min. Bundle Diameter		Width		Thickness		Recommended PANDUIT® Installation Tool***	Std. Pkg. Qty.	Std. Ctn. Qty.
	In.	mm	In.	mm	Lbs.	N	In.	mm	In.	mm	In.	mm			

AISI 304 Stainless Steel – For Superior Grip on Rigid Bundles

NEW! Standard Cross Section

MLT2.7WS-LP	2.7	69	10.2	259	200	890	2.0	51	.18	4.6	.010	.25	GS4MT, HTMT, PPTMT, ST2MT or ST3MT	50	250
MLT4WS-LP	4.0	102	14.3	362	200	890	2.0	51	.18	4.6	.010	.25		50	250
MLT6WS-LP	6.0	152	20.5	521	200	890	2.0	51	.18	4.6	.010	.25		50	250
MLT8WS-LP	8.0	203	26.8	679	200	890	2.0	51	.18	4.6	.010	.25		50	250

NEW! Light-Heavy Cross Section

MLT2.7WLH-LP	2.7	69	10.2	259	250	1112	2.0	51	.25	6.4	.010	.25	GS4MT, HTMT, PPTMT, ST2MT or ST3MT	50	250
MLT4WLH-LP	4.0	102	14.3	362	250	1112	2.0	51	.25	6.4	.010	.25		50	250
MLT6WLH-LP	6.0	152	20.5	521	250	1112	2.0	51	.25	6.4	.010	.25		50	250
MLT8WLH-LP	8.0	203	26.8	679	250	1112	2.0	51	.25	6.4	.010	.25		50	250

Heavy Cross Section

MLT2.7WH-LP	2.7	69	10.2	259	450	2000	2.0	51	.31	7.9	.010	.25	GS4MT, HTMT, PPTMT, ST2MT or ST3MT	50	250
MLT4WH-LP	4.0	102	14.3	362	450	2000	2.0	51	.31	7.9	.010	.25		50	250
MLT6WH-LP	6.0	152	20.5	521	450	2000	2.0	51	.31	7.9	.010	.25		50	250
MLT8WH-LP	8.0	203	26.8	679	450	2000	2.0	51	.31	7.9	.010	.25		50	250
MLT10WH-LP	10.0	254	33.0	838	450	2000	2.0	51	.31	7.9	.010	.25		50	250

NEW! Standard Cross Section

MLT2.7WS-LP316	2.7	69	10.2	259	200	890	2.0	51	.18	4.6	.010	.25	GS4MT, HTMT, PPTMT, ST2MT or ST3MT	50	250
MLT4WS-LP316	4.0	102	14.3	362	200	890	2.0	51	.18	4.6	.010	.25		50	250
MLT6WS-LP316	6.0	152	20.5	521	200	890	2.0	51	.18	4.6	.010	.25		50	250
MLT8WS-LP316	8.0	203	26.8	679	200	890	2.0	51	.18	4.6	.010	.25		50	250

NEW! Light-Heavy Cross Section

MLT2.7WLH-LP316	2.7	69	10.2	259	250	1112	2.0	51	.25	6.4	.010	.25	GS4MT, HTMT, PPTMT, ST2MT or ST3MT	50	250
MLT4WLH-LP316	4.0	102	14.3	362	250	1112	2.0	51	.25	6.4	.010	.25		50	250
MLT6WLH-LP316	6.0	152	20.5	521	250	1112	2.0	51	.25	6.4	.010	.25		50	250
MLT8WLH-LP316	8.0	203	26.8	679	250	1112	2.0	51	.25	6.4	.010	.25		50	250

Heavy Cross Section

MLT2.7WH-LP316	2.7	69	10.2	259	450	2000	2.0	51	.31	7.9	.010	.25	GS4MT, HTMT, PPTMT, ST2MT or ST3MT	50	250
MLT4WH-LP316	4.0	102	14.3	362	450	2000	2.0	51	.31	7.9	.010	.25		50	250
MLT6WH-LP316	6.0	152	20.5	521	450	2000	2.0	51	.31	7.9	.010	.25		50	250
MLT8WH-LP316	8.0	203	26.8	679	450	2000	2.0	51	.31	7.9	.010	.25		50	250

*Per SAE Standard AS23190/3 (formerly MIL). For additional details, refer to page F1.

**Other lengths available, contact customer service.

***For information on installation tools, refer to page B12-B14.

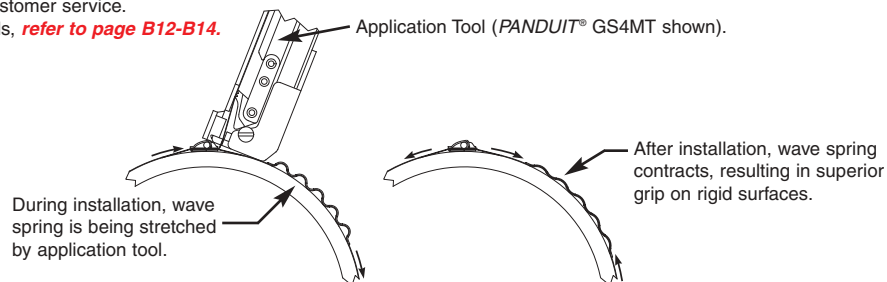

Index

PAN-STEEL® Custom Length Banding System (Coated and Non-Coated)

Custom Length Banding System MBS, MBH, MBEH and MBSH Banding

- For applications that require bundling various bundle diameters
- Supplied in reels of 200 ft (61m), 250 ft (76m) or 1000 ft (305m)
- Bundle any size bundle diameter
- To use, pull out as much banding as needed, cut off using GS4MT with CAMT accessory or with shears and install with MTHS or MTHH banding heads

Polyester coating option provides:

- Low smoke
- Halogen free
- Temperature tolerance -40°F (-40°C) to -302°F (150°C)
- Good UV resistance

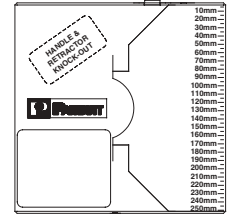

Part Number	Max. Bundle Diameter		Length**		Min. Loop Tensile Strength*		Min. Bundle Diameter		Width		Thickness		Recommended PANDUIT® Installation Tool***	Recommended Banding Head	Std. Pkg. Qty.
	In.	mm	Ft.	M	Lbs.	N	In.	mm	In.	mm	In.	mm			

AISI 304 Stainless Steel – For General Purpose Banding

Standard Cross Section

MBS-TLR	Any	Any	250	76	100	445	.50	12.7	.18	4.4	.010	.25	GS4MT, HTMT, PPTMT, ST2MT, ST3MT	MTHS-C	1
MBS-MR	Any	Any	1000	305	100	445	.50	12.7	.18	4.4	.010	.25		MTHS-C	1

Heavy Cross Section

MBH-TLR	Any	Any	250	76	250	1112	.50	12.7	.31	7.9	.010	.25	GS4MT, HTMT, PPTMT, ST2MT, ST3MT	MTHH-C	1
MBH-MR	Any	Any	1000	305	250	1112	.50	12.7	.31	7.9	.010	.25		MTHH-C	1

NEW! Extra-Heavy Cross Section

MBEH-TLR	Any	Any	250	76	300	1335	1.0	25.4	.50	12.7	.010	.25	RT1HT, ST3MT	MTHEH-C	1
-----------------	-----	-----	-----	----	-----	------	-----	------	-----	------	------	-----	--------------	---------	---

NEW! Super-Heavy Cross Section

MBSH-TR	Any	Any	200	61	450	2000	1.0	25.4	.63	15.9	.015	.38	RT1HT	MTHSH-C	1
----------------	-----	-----	-----	----	-----	------	-----	------	-----	------	------	-----	-------	---------	---

AISI 316 Stainless Steel – For Superior Corrosion Resistance

Standard Cross Section

MBS-TLR316	Any	Any	250	76	100	445	.50	12.7	.18	4.4	.010	.25	GS4MT, HTMT, PPTMT, ST2MT, ST3MT	MTHS-C316	1
MBS-MR316	Any	Any	1000	305	100	445	.50	12.7	.18	4.4	.010	.25		MTHS-C316	1

Heavy Cross Section

MBH-TLR316	Any	Any	250	76	250	1112	.50	12.7	.31	7.9	.010	.25	GS4MT, HTMT, PPTMT, ST2MT, ST3MT	MTHH-C316	1
MBH-MR316	Any	Any	1000	305	250	1112	.50	12.7	.31	7.9	.010	.25		MTHH-C316	1

NEW! Extra-Heavy Cross Section

MBEH-TLR316	Any	Any	250	76	300	1335	1.0	25.4	.50	12.7	.010	.25	RT1HT, ST3MT	MTHEH-C316	1
--------------------	-----	-----	-----	----	-----	------	-----	------	-----	------	------	-----	--------------	------------	---

NEW! Super-Heavy Cross Section

MBSH-TR316	Any	Any	200	61	450	2000	1.0	25.4	.63	15.9	.015	.38	RT1HT	MTHSH-C316	1
-------------------	-----	-----	-----	----	-----	------	-----	------	-----	------	------	-----	-------	------------	---

NEW! Polyester Coated AISI 316 Stainless Steel

Heavy Cross Section

MBCH-QR316	Any	Any	82	25	250	1112	N/A	N/A	.31	7.9	.010	.25	GS4MT, HTMT, PPTMT, ST2MT or ST3MT	MTHH-C316	1
-------------------	-----	-----	----	----	-----	------	-----	-----	-----	-----	------	-----	------------------------------------	-----------	---

NEW! Extra-Heavy Cross Section

MBCEH-QR316	Any	Any	82	25	300	1335	N/A	N/A	.50	12.7	.010	.25	RT1HT, ST3MT	MTHEH-C316	1
--------------------	-----	-----	----	----	-----	------	-----	-----	-----	------	------	-----	--------------	------------	---

NEW! Super-Heavy Cross Section

MBCSH-QR316	Any	Any	82	25	450	2000	N/A	N/A	.63	15.9	.015	.38	RT1HT	MTHSH-C316	1
--------------------	-----	-----	----	----	-----	------	-----	-----	-----	------	------	-----	-------	------------	---

*Per SAE Standard AS23190/3 (formerly MIL). For additional details, refer to page F1.

**The GS4MT with CAMT accessory is recommended for cutting the banding. This system provides a straight cut-off which assists in head assembly and eliminates the need for shears.

***For information on installation tools, refer to pages B12-B14.

To determine the proper amount of banding required, use the following formula to determine length of banding needed

Calculate Diameter inches (mm) x 3.14 + 3 inches (76mm)

Example: 10 in. (250mm) Diameter Bundle

10 in. (250mm) x 3.14 = 31.40 + 3 in. (76mm) = 34.40 in. or 35 in. (861mm) of banding required.

Markets

Custom Length Banding Dispenser System

MLT Ties

MS Strapping

Marking and ID

Accessories

Technical Info

Index

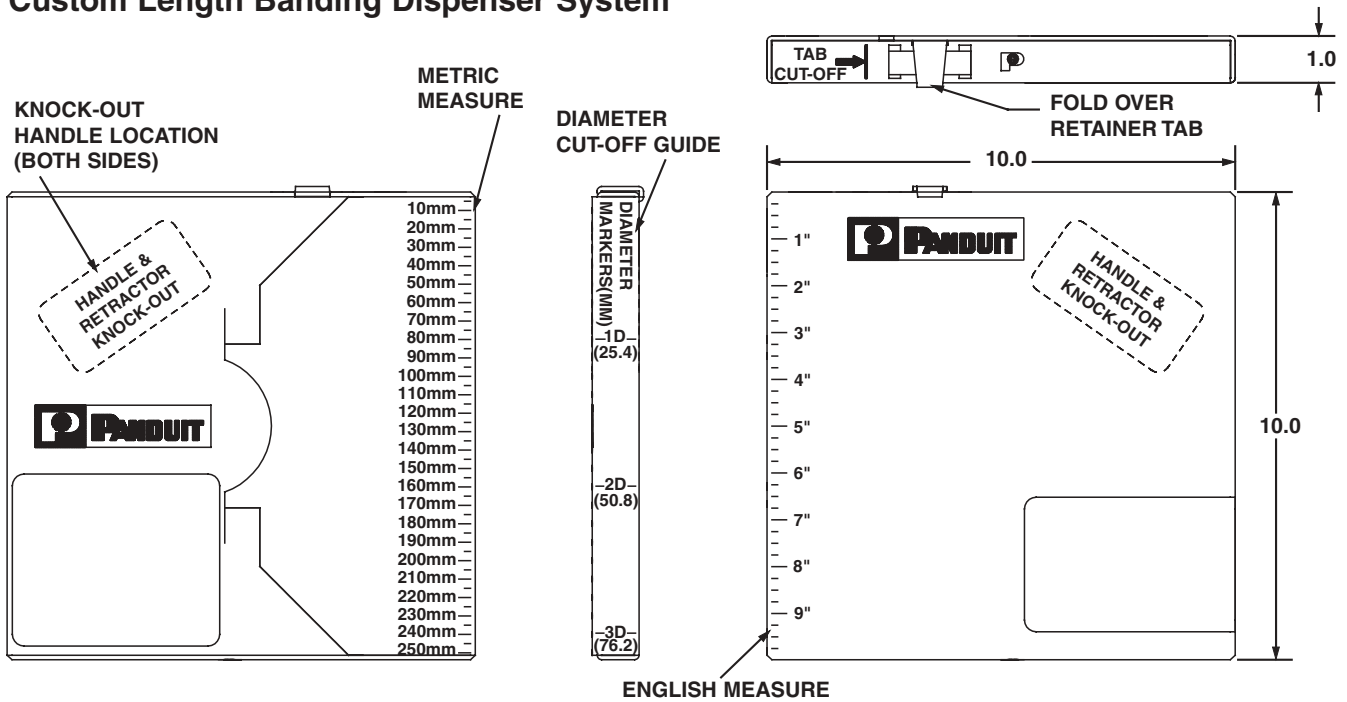

MTHS, MTHH, MTHEH and MTHS Banding Heads



- To use, take one end of the cut banding and bend back 1/2" (13mm)
- Take a self-locking head and slide it the entire length of the band until it reaches the bend
- Bend tail flat against bottom of banding head to complete assembly

Part Number	Part Description	Std. Pkg. Qty.	Std. Ctn. Qty.
AISI 304 Stainless Steel – For Banding Heads			
MTHS-C	Loose piece banding head for standard cross section banding 304 stainless steel.	100	1000
MTHH-C	Loose piece banding head for heavy cross section banding 304 stainless steel.	100	1000
MTHEH-C	Loose piece banding head for extra-heavy cross section banding 304 stainless steel.	100	1000
MTHSH-C	Loose piece banding head for super heavy cross section banding 304 stainless steel.	100	1000
AISI 316 Stainless Steel – For Banding Heads			
MTHS-C316	Loose piece banding head for standard cross section banding 316 stainless steel.	100	1000
MTHH-C316	Loose piece banding head for heavy cross section banding 316 stainless steel.	100	1000
MTHEH-C316	Loose piece banding head for extra-heavy cross section banding 316 stainless steel.	100	1000
MTHSH-C316	Loose piece banding head for super heavy cross section banding 316 stainless steel.	100	1000

PAN-STEEL® Coated Stainless Steel Cable Ties

Enhanced Patented Nylon 11 Selectively Coated Ties – MLTC Series



- For communication and electrical cables
- Strength of steel, the protection of nylon; the nylon coating provides protection for the cables
- Available in loop tensile strength of 250 lbs.
- Base metal 316 grade stainless steel for excellent resistance to temperature extremes, corrosion, weather, chemicals, salt sprays and UV radiation

Nylon 11 Coating:

- Resistance to chemicals and salt sprays
- Halogen-free
- Temperature tolerance -40°F (-40°C) to 285°F (140°C)
- Coating thickness .003 in. (.08mm) / .005 in. (.13mm) per side

Part Number	Max. Bundle Diameter		Length		Min. Loop Tensile Strength*		Min. Bundle Diameter		Width		Thickness**		Recommended PANDUIT® Installation Tool***	Std. Pkg. Qty.	Std. Ctn. Qty.
	In.	mm	In.	mm	Lbs.	N	In.	mm	In.	mm	In.	mm			

AISI 316 Stainless Steel – For Nylon 11 Selectively Coated Cable Ties

Heavy Cross Section

MLTC2H-LP316	2.0	51	7.9	201	250	1112	.50	12.7	.31	7.9	.010	.25	GS4MT, HTMT, PPTMT, ST2MT or ST3MT	50	250
MLTC4H-LP316	4.0	102	14.3	362	250	1112	.50	12.7	.31	7.9	.010	.25		50	250
MLTC6H-LP316	6.0	152	20.5	521	250	1112	.50	12.7	.31	7.9	.010	.25		50	250
MLTC8H-LP316	8.0	203	26.8	679	250	1112	.50	12.7	.31	7.9	.010	.25		50	250
MLTC10H-LP316	10.0	254	33.0	838	250	534	.50	12.7	.31	7.90	.010	.25		50	250

*Per SAE Standard AS23190/3 (formerly MIL). For additional details, refer to page F1.

**Base material less coating.

***For information on installation tools, refer to pages B12-B14.

Fully Coated Ties



- Polyester coating
- Base metal 316 grade stainless steel
- Self-locking with low thread force
- Available in standard, light-heavy, heavy, and extra-heavy cross sections
- Low smoke
- Halogen free
- Temperature tolerance -40°F (-40°C) to -302°F (150°C)
- Good UV resistance

Part Number	Max. Bundle Diameter		Length		Min. Loop Tensile Strength*		Min. Bundle Diameter		Width		Thickness**		Recommended PANDUIT® Installation Tool***	Std. Pkg. Qty.	Std. Ctn. Qty.
	In.	mm	In.	mm	Lbs.	N	In.	mm	In.	mm	In.	mm			

NEW! Standard Cross Section

MLTFC2S-CP316	2.0	51	7.9	201	100	445	.50	12.7	.18	4.6	.010	.25	GS4MT, HTMT, PPTMT, ST2MT, or ST3MT	100	500
MLTFC4S-CP316	4.0	102	14.3	362	100	445	.50	12.7	.18	4.6	.010	.25		100	500
MLTFC6S-CP316	6.0	152	20.5	521	100	445	.50	12.7	.18	4.6	.010	.25		100	500
MLTFC8S-CP316	8.0	203	26.8	679	100	445	.50	12.7	.18	4.6	.010	.25		100	500

NEW! Light-Heavy Cross Section

MLTFC2LH-LP316	2.0	51	7.9	201	150	668	.50	12.7	.25	6.4	.010	.25	GS4MT, HTMT, PPTMT, ST2MT, or ST3MT	50	250
MLTFC4LH-LP316	4.0	102	14.3	362	150	668	.50	12.7	.25	6.4	.010	.25		50	250
MLTFC6LH-LP316	6.0	152	20.5	521	150	668	.50	12.7	.25	6.4	.010	.25		50	250
MLTFC8LH-LP316	8.0	203	26.8	679	150	668	.50	12.7	.25	6.4	.010	.25		50	250

NEW! Heavy Cross Section

MLTFC2H-LP316	2.0	51	7.9	201	250	1112	.50	12.7	.31	7.9	.010	.25	GS4MT, HTMT, PPTMT, ST2MT, or ST3MT	50	250
MLTFC4H-LP316	4.0	102	14.3	362	250	1112	.50	12.7	.31	7.9	.010	.25		50	250
MLTFC6H-LP316	6.0	152	20.5	521	250	1112	.50	12.7	.31	7.9	.010	.25		50	250
MLTFC8H-LP316	8.0	203	26.8	679	250	1112	.50	12.7	.31	7.9	.010	.25		50	250

NEW! Extra-Heavy Cross Section

MLTFC2EH-LP316	2.0	51	11.8	300	300	1335	N/A	N/A	.50	12.7	.010	.25	RT1HT or ST3MT	50	250
MLTFC4EH-LP316	4.0	102	17.1	434	300	1335	N/A	N/A	.50	12.7	.010	.25		50	250
MLTFC6EH-LP316	6.0	152	23.4	574	300	1335	N/A	N/A	.50	12.7	.010	.25		50	250
MLTFC8EH-LP316	8.0	203	29.7	754	300	1335	N/A	N/A	.50	12.7	.010	.25		50	250

*Per SAE Standard AS23190/3 (formerly MIL). For additional details, refer to page F1.

**Base material less coating.

***For information on installation tools, refer to pages B12-B14.

Markets

PCS Cushion Sleeve

MLT Ties



- Black vinyl sleeving slips on standard and heavy cross section *PAN-STEEL*® Stainless Steel Ties and Custom Length Banding
- Used on applications requiring improved gripping on non-resilient objects
- Can be used indoors or outdoors (excellent ultraviolet resistance, good resistance to petroleum, and many chemicals)
- Provides full separation between the ties and the material to which you are fastening
- Operating temperature range 41°F – 167°F (5°C to 75°C)

MS Strapping

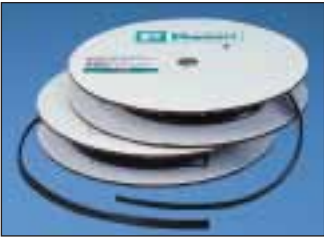

Part Number	Width		Length		Std. Pkg. Qty.
	In.	mm	Ft.	M	
PCSS-CR	.31	.87	100	30.5	1
PCSH-CR	.47	11.9	100	30.5	1

Bulk Pkg. -CR = 100 ft. (30.5m) reel.

Marking and ID

Accessories

Technical Info

Index

PAN-STEEL® Double Wrapped Stainless Steel Cable Ties

PAN-STEEL® Double Wrapped Stainless Steel Cable Ties — MLTDH Series



Cable tie body passes through head two times

- Available in 304 and 316 stainless steel for extra high strength in critical applications
- Allow for tighter tensioning on non-resilient bundles
- Available in .31 in. (7.9mm), .50 in. (12.7mm), .625 in. (15.9mm) width for bundle diameters ranging from 1-8 in. (203mm)
- Loop tensile strength up to 1200 lbs. (5340 N)
- Self-locking ties — no tools required
- Optional tooling is available to speed installation and lower installed costs

MLT Ties

Part Number	Max. Bundle Diameter		Length**		Min. Loop Tensile Strength*		Min. Bundle Diameter		Width		Thickness		Recommended PANDUIT® Installation Tool***	Std. Pkg. Qty.	Std. Ctn. Qty.
	In.	mm	In.	mm	Lbs.	N	In.	mm	In.	mm	In.	mm			

AISI 304 Stainless Steel — MLTDH Double Wrapped Ties

Heavy Cross Section

MLT2DH-L	2.0	50	18.5	470	600	2670	1.0	25.4	.31	7.9	.010	.25	GS4MT, HTMT, PPTMT, ST2MT, or ST3MT	50	250
MLT4DH-L	4.0	102	28.0	711	600	2670	1.0	25.4	.31	7.9	.010	.25		50	250
MLT5DH-L	5.0	125	34.0	863	600	2670	1.0	25.4	.31	7.9	.010	.25		50	250

NEW! Extra-Heavy Cross Section

MLT4DEH-Q	4.0	102	29.5	749	800	3560	1.0	25.4	.50	12.7	.010	.25	RT1HT, ST3MT	25	125
MLT6DEH-Q	6.0	152	41.5	1054	800	3560	1.0	25.4	.50	12.7	.010	.25		25	125
MLT8DEH-Q	8.0	203	53.5	1359	800	3560	1.0	25.4	.50	12.7	.010	.25		25	125
MLT4DEH15-Q	4.0	102	29.5	749	1000	4450	1.0	25.4	.50	12.7	.015	.38		25	125
MLT6DEH15-Q	6.0	152	41.5	1054	1000	4450	1.0	25.4	.50	12.7	.015	.38		25	125
MLT8DEH15-Q	8.0	203	53.5	1359	1000	4450	1.0	25.4	.50	12.7	.015	.38		25	125

NEW! Super-Heavy Cross Section

MLT4DSH-Q	4.0	102	29.5	749	1200	5340	1.0	25.4	.625	15.9	.015	.38	RT1HT	25	125
MLT6DSH-Q	6.0	152	41.5	1054	1200	5340	1.0	25.4	.625	15.9	.015	.38		25	125
MLT8DSH-Q	8.0	203	53.5	1359	1200	5340	1.0	25.4	.625	15.9	.015	.38		25	125

AISI 316 Stainless Steel — For MLTDH Double Wrapped Ties

NEW! Extra-Heavy Cross Section

MLT4DEH-Q316	4.0	102	29.5	749	800	3560	1.0	25.4	.50	12.7	.010	.25	RT1HT, ST3MT	25	125
MLT6DEH-Q316	6.0	152	41.5	1054	800	3560	1.0	25.4	.50	12.7	.010	.25		25	125
MLT8DEH-Q316	8.0	203	53.5	1359	800	3560	1.0	25.4	.50	12.7	.010	.25		25	125
MLT4DEH15-Q316	4.0	102	29.5	749	1000	4450	1.0	25.4	.50	12.7	.015	.38		25	125
MLT6DEH15-Q316	6.0	152	41.5	1054	1000	4450	1.0	25.4	.50	12.7	.015	.38		25	125
MLT8DEH15-Q316	8.0	203	53.5	1359	1000	4450	1.0	25.4	.50	12.7	.015	.38		25	125

NEW! Super-Heavy Cross Section

MLT4DSH-Q316	4.0	102	29.5	749	1200	5340	1.0	25.4	.625	15.9	.015	.38	RT1HT	25	125
MLT6DSH-Q316	6.0	152	41.5	1054	1200	5340	1.0	25.4	.625	15.9	.015	.38		25	125
MLT8DSH-Q316	8.0	203	53.5	1359	1200	5340	1.0	25.4	.625	15.9	.015	.38		25	125

*Per SAE Standard AS23190/3 (formerly MIL). For additional details, refer to page F1.

**Other lengths available, contact customer service.

***For information on installation tools, refer to pages B12-B14.

MS Strapping

Marking and ID

Accessories

Technical Info

Index

Markets

Installation Tools for All Stainless Steel Cable Ties and Custom Length Banding System

A large selection of state-of-the-art installation tooling allows you to choose the proper tool to meet all your requirements, no matter what your application. These tools are lightweight and easy to operate. Because they are fast and efficient they speed cable tie installation and lower your total installed cost. The *PANDUIT®* PPTMT and GS4MT tools automatically cut off excess tie when the pre-set tension level is reached.



ST3MT, PPTMT, HTMT, GS4MT, RT1HT

MLT Ties

MS Strapping

PPTMT Installation Tool



PPTMT (Pneumatic)

- Power assisted tool for fast and effortless installation
- Cable tie side entry for immediate positioning of tie and tool
- Controlled tension, fully adjustable
- Automatic cut-off
- One hand operation — lightweight
- Easy removal of excess tie
- Operates 85 PSI - 586 KPA Bar non-lubricated air and requires no special maintenance

Marking and ID

Part Number	Part Description	Std. Pkg. Qty.
PPTMT	Pneumatic hand tool used with <i>PAN-STEEL®</i> Type MLT ties, Type MLTC coated ties, Type MLTDH double wrapped ties and <i>WAVE-TY™</i> Stainless Steel Ties. Automatically tensions and cuts off tie when predetermined tension is reached, providing more reliable and consistent installations. Ideal for high production applications. Installs standard .18 in. (4.6mm), light-heavy .25 in. (6.4mm) and heavy .31 in. (7.9mm) cross section ties.	1
PPH10	10 ft. (3 m) hose assembly; 1/8 in. (3.175 mm) NPT male connector	1
PL289N1	Filter regulator	1
KPPTMTG	Replacement gripper kit for PPTMT	1
KPPTMTB	Replacement blade kit for PPTMT	1

Power assisted (pneumatic tool) will automatically tension and cut off excess tie when predetermined tension is reached with the squeeze of a trigger.

Accessories



Side Entry

Technical Info

Adjustment Features for PPTMT and GS4MT Tools*

Fast and Easy Selection



The cross-section of the cable tie being installed is clearly indicated on the knob. To change,

simply flip knob to proper cross-section indicator.

Tension Indicator



Each cross-section of cable ties can be installed with a variety of tensions to meet the application.

The proper tensions (listed on *PANDUIT®* cable tie packages) are clearly marked with this indicator.

To Change the Tension:



Turn clockwise to increase.



Turn counter-clockwise to decrease.

Index

*For information on GS4MT installation tool, refer to page B13.

GS4MT Installation Tool



Hand Operated Tool

- Single handle operation for fast installation
- Cable tie side entry for immediate positioning of tie and tool
- Controlled tension, fully adjustable
- Easy removal of excess tie
- Qualified product listed per SAE Standard MS90387-3
- Automatically tensions and cuts off tie when predetermined tension is reached, providing more reliable and consistent installations*
- Installs standard .18 in. (4.6mm), light-heavy .25 in. (6.4mm) and heavy .31 in. (7.9mm) cross section ties

Part Number	Part Description	Std. Pkg. Qty.
GS4MT	Used with standard, light-heavy and heavy cross section <i>PAN-STEEL</i> ® Type MLT ties, Type MLTC Coated ties, Type MLTDH Double Wrapped ties and <i>WAVE-TY</i> ™ Stainless Steel Ties.	1
K4M-BLD	Replacement cutter blade for GS4MT	1
K4MTG	Replacement tension gripper for GS4MT	1
CAMT	Cut-off accessory. Use this accessory with GS4MT tool to cut MBH or MBS continuous banding. Accessory drops in place for use.	1

* When installing over resilient objects (or made resilient by using PCS cushion sleeve).



CAMT



SIDE ENTRY

Tool Tension Lock Kit



To lock selector knob and tension level



To lock fine adjustment

- For applications requiring a locking device on either the selector knob (one cross-section size and tension only) or tension level adjustment (but allow cross-section size changes)
- Replacement blade kits and gripper replacement kits can be part of a scheduled maintenance plan or used when cut-offs are not clean and crisp

Part Number	Part Description	Std. Pkg. Qty.
TTLK3	Tool Tension Locking Kit for GS4MT and PPTMT installation tools.	1

Markets

ST3MT Installation Tool



Hand operated tool with installer controlled tension and cut-off.

- Cable tie side entry for immediate positioning of tie and tool
- One hand operation — lightweight
- Easy removal of excess tie
- Tool tension is controlled by installer. Lever actuated cut-off
- Rugged, lightweight, easy-to-operate pliers-type tool provides mechanical advantage

Part Number	Part Description	Std. Pkg. Qty.
ST3MT	Used with standard, light-heavy, heavy, and extra-heavy cross section <i>PAN-STEEL</i> ® Type MLT ties, Type MLTC coated ties, Type MLTDH double wrapped ties and <i>WAVE-TY</i> ™ Stainless Steel Ties.	1
KT3MG	Replacement tension gripper for ST3MT tool.	1

MLT Ties

MS Strapping

RT1HT Installation Tool



Hand operated tool with adjustable tension control and lever cut-off.

- Cable tie side entry for immediate positioning of tie and tool
- One or two hand tensioning with multi-position rear handle
- Adjustable tension control
- Lever actuated cut-off
- Easy removal of excess tie
- Ratchet style tool for high tension
- Rugged, lightweight, easy-to-operate ratchet tool provides mechanical advantage

Part Number	Part Description	Std. Pkg. Qty.
RT1HT	Used with extra-heavy and super-heavy cross section <i>PAN-STEEL</i> ® Type MLT ties, Type MLTFC coated ties and type MLTDH double wrapped ties.	1

Marking and ID

Accessories



HTMT Installation Tool



Installer controlled tension.

- Economical
- The coiled tie end remaining after tensioning assures a safe end
- No sharp edges
- Manual tension, no cut-off
- Installs ties parallel to the bundle

Part Number	Part Description	Std. Pkg. Qty.
HTMT	Used with standard, light-heavy and heavy cross section <i>PAN-STEEL</i> ® Type MLT ties, Type MLTC coated ties, Type MLTDH double wrapped ties and <i>WAVE-TY</i> ™ Stainless Steel Ties.	1

Technical Info

Index

PAN-STEEL® Stainless Steel Strapping (MS Series)

PANDUIT® continues to provide innovative products that create the ultimate solution for strapping applications. A new buckle design and tension controlled installation tool offer a quick and safe installation for all harsh environments applications.



- Increased loop tensile strength for an extra margin of safety
- Increased retained tension for a more secure bundle
- No sharp edges after installation
- Simplified installation versus ear lock straps
- Fully assembled discrete lengths

PANDUIT® offers unique products to meet customer needs:

General Purpose Straps — Excellent performance in any environment, available in three widths

Fully Coated Straps — Strength of steel with the protection and safety of nylon

Custom Length Strapping System — For use with large bundles

Installation Tool — For controlled tension, lever cut-off and lower installed cost

PANDUIT® PAN-STEEL® System FOR HARSH ENVIRONMENTS

Markets

PANDUIT® PAN-STEEL® Stainless Steel Strapping System

MLT Ties



The PANDUIT® PAN-STEEL® Stainless Steel Strapping System reduces installation time and leaves no sharp edges.

- 3 widths available: 3/8 in. (9.5mm), 1/2 in. (12.7mm), and 5/8 in. (15.9mm)
- Burr-free sides
- 304 and 316 stainless steel
- Designed for use in critical applications where strength, radiation, weathering, corrosion, and temperature extremes are a concern
- Temperature range: -112°F (-80°C) to 1000°F (538°C)

MS Strapping

Unique Patented Locking Method

Buckle design provides a low finished profile



After tensioning, cut end is locked inside buckle — no exposed sharp edge

Marking and ID

Hooked Clamping Tab*

Bends strap body within retention area of buckle for increased loop tensile strength and full coverage of cut end of strap

Cross Rib Support*

Enhanced rigidity for higher loop tensile strength

Concave Cross-section*

Enhanced support to improve tensile strength

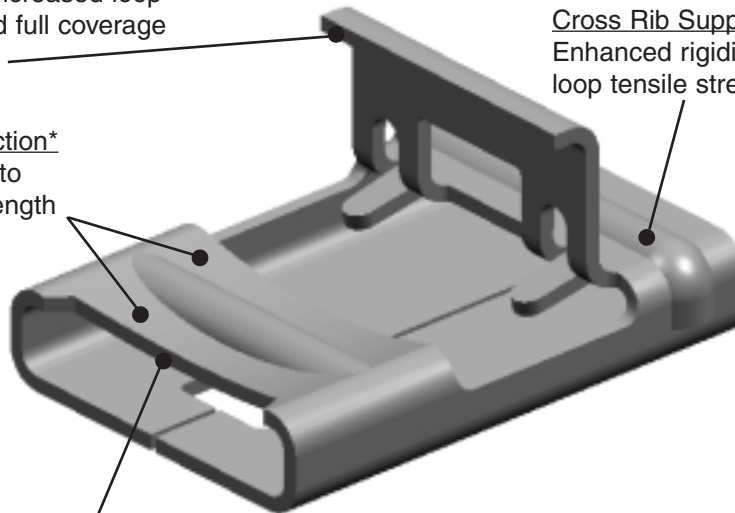

Concave Buckle Recess*

Increases body resistance for increased loop tensile strength

*Patents Pending

Accessories

Technical Info

Index

The PANDUIT® Method Reduces Installation Time



1. Place strap around the material, insert tail of strap through buckle. Pull strapping tight and bend up to hold in place. Insert tail of strapping into tool nose section. Squeeze handle to tension.



2. Once proper tension is reached, maintain tension and raise tool 90° – 120° over buckle and pull down on cutter lever, cutting strap.



3. Remove tool, press cut end down and toward retaining tab.



4. Using the closure lever on the handle of the tool, bend retaining tab down and over cut end. Provides finished, safe, low profile closure.



Part Number System Example

Discrete Length Part Numbering System

<u>MS</u>	<u>4</u>	<u>W</u>	<u>38</u>	<u>T</u>	<u>15</u>	<u>L</u>	<u>4</u>
Part Description	Bundle	Width	Inches	Thickness	15 = 0.015"	Package Qty.	Material
Metal	Diameter		38 = 3/8				4 = 304 SS
Strap	Inches		50 = 1/2			L = 50 Pcs.	6 = 316 SS
(C=Coated)			63 = 5/8				
(blank=Uncoated)							

Stainless Steel Coil Part Number System

<u>MS</u>	<u>W</u>	<u>50</u>	<u>T</u>	<u>15</u>	<u>CR</u>	<u>6</u>
Part Description	Width	Inches	Thickness	15 = 0.015"	Package Qty.	Material
Metal		38 = 3/8				4 = 304 SS
Strap		50 = 1/2			QR = 25m	6 = 316 SS
(C=Coated)		63 = 5/8			CR = 100 ft	
(blank=Uncoated)						

Stainless Steel Buckle Part Number System

<u>MS</u>	<u>B</u>	<u>W</u>	<u>63</u>	<u>C</u>	<u>4</u>
Part Description	B = Buckle	Width	Inches	Package Qty.	Material
Metal			38 = 3/8		4 = 304 SS
Strap			50 = 1/2	C = 100 Pcs	6 = 316 SS
			63 = 5/8		

PANDUIT® PAN-STEEL® System FOR HARSH ENVIRONMENTS

Markets

PAN-STEEL® Stainless Steel Strapping



- Buckle design provides a low finished profile
- After tensioning, cut end is locked inside buckle — no sharp edges
- Buckle locked in place — will not slip down strap
- Available in 316 material for the most corrosive environments

MLT Ties

MS Strapping

Marking and ID

Accessories

Technical Info

Index

Part Number	Max. Bundle Diameter		Length		Min. Loop Tensile Strength*		Min. Bundle Diameter		Width		Thickness		Recommended PANDUIT® Installation Tool	Std. Pkg. Qty.	Std. Ctn. Qty.
	In.	mm	In.	mm	Lbs.	N	In.	mm	In.	mm	In.	mm			
AISI 304 Stainless Steel															
MS2W38T15-L4	2.0	51	11.8	300	500	2225	1.0	25.4	.38	9.5	.015	.38	BT1HT, BT2MS75	50	250
MS4W38T15-L4	4.0	102	18.0	457	500	2225	1.0	25.4	.38	9.5	.015	.38		50	250
MS6W38T15-L4	6.0	152	24.4	620	500	2225	1.0	25.4	.38	9.5	.015	.38		50	250
MS8W38T15-L4	8.0	203	30.7	780	500	2225	1.0	25.4	.38	9.5	.015	.38		50	250
MS10W38T15-L4	10.0	254	37.0	790	500	2225	1.0	25.4	.38	9.5	.015	.38		50	250
MS4W50T15-L4	4.0	102	18.0	457	700	3115	1.0	25.4	.50	12.7	.015	.38		50	250
MS6W50T15-L4	6.0	152	24.4	620	700	3115	1.0	25.4	.50	12.7	.015	.38		50	250
MS8W50T15-L4	8.0	203	30.7	780	700	3115	1.0	25.4	.50	12.7	.015	.38		50	250
MS10W50T15-L4	10.0	254	37.0	940	700	3115	1.0	25.4	.50	12.7	.015	.38		50	250
MS4W63T15-L4	4.0	102	18.0	457	800	3560	1.0	25.4	.63	15.9	.015	.38		50	250
MS6W63T15-L4	6.0	152	24.4	620	800	3560	1.0	25.4	.63	15.9	.015	.38	50	250	
MS8W63T15-L4	8.0	203	30.7	780	800	3560	1.0	25.4	.63	15.9	.015	.38	50	250	
MS10W63T15-L4	10.0	254	37.0	940	800	3560	1.0	25.4	.63	15.9	.015	.38	50	250	
AISI 316 Stainless Steel															
MS2W38T15-L6	2.0	51	11.8	300	500	2225	1.0	25.4	.38	9.5	.015	.38	BT1HT, BT2MS75	50	250
MS4W38T15-L6	4.0	102	18.0	457	500	2225	1.0	25.4	.38	9.5	.015	.38		50	250
MS6W38T15-L6	6.0	152	24.4	620	500	2225	1.0	25.4	.38	9.5	.015	.38		50	250
MS8W38T15-L6	8.0	203	30.7	780	500	2225	1.0	25.4	.38	9.5	.015	.38		50	250
MS10W38T15-L6	10.0	254	37.0	940	500	2225	1.0	25.4	.38	9.5	.015	.38		50	250
MS4W50T15-L6	4.0	102	18.0	457	700	3115	1.0	25.4	.50	12.7	.015	.38		50	250
MS6W50T15-L6	6.0	152	24.4	620	700	3115	1.0	25.4	.50	12.7	.015	.38		50	250
MS8W50T15-L6	8.0	203	30.7	780	700	3115	1.0	25.4	.50	12.7	.015	.38		50	250
MS10W50T15-L6	10.0	254	37.0	940	700	3115	1.0	25.4	.50	12.7	.015	.38		50	250
MS4W63T15-L6	4.0	102	18.0	457	800	3560	1.0	25.4	.63	15.9	.015	.38		50	250
MS6W63T15-L6	6.0	152	24.4	620	800	3560	1.0	25.4	.63	15.9	.015	.38	50	250	
MS8W63T15-L6	8.0	203	30.7	780	800	3560	1.0	25.4	.63	15.9	.015	.38	50	250	
MS10W63T15-L6	10.0	254	37.0	940	800	3560	1.0	25.4	.63	15.9	.015	.38	50	250	

*Per SAE Standard AS23190/3 (formerly MIL). For additional details, refer to pages F1.

Custom Length Strapping



- For applications that require various bundle diameters
- Supplied in reels of 100 ft. (30.5m) and 82.5 ft. (25m)
- 304 and 316 stainless steel
- Provides job-site versatility with minimum inventory
- Available with Nylon 11 coating or PPA 571 coating for additional edge protection

Part Number	Min. Loop Tensile Str.*		Width		Thickness**		Used with Buckle	Tool	Std. Pkg. Qty.***
	Lbs.	N	In.	mm	In.	mm			
304 Stainless Steel									
MSW38T15-CR4	500	2225	.38	9.5	.015	.38	MSBW38-C4	BT1HT, BT2MS75	1
MSW50T15-CR4	500	2225	.50	12.7	.015	.38	MSBW50-C4		1
MSW63T15-CR4	500	2225	.63	15.9	.015	.38	MSBW63-C4		1
316 Stainless Steel									
MSW38T15-CR6	700	3115	.38	9.5	.015	.38	MSBW38-C6	BT1HT, BT2MS75	1
MSW50T15-CR6	700	3115	.50	12.7	.015	.38	MSBW50-C6		1
MSW63T15-CR6	700	3115	.63	15.9	.015	.38	MSBW63-C6		1
Nylon Coated Custom Length Strapping									
MSCNW38T15-QR6	800	3560	.38	9.5	.015	.38	MSBW38-C6	BT1HT, BT2MS75	1
MSCNW50T15-QR6	800	3560	.50	12.7	.015	.38	MSBW50-C6		1
MSCNW63T15-QR6	800	3560	.63	15.9	.015	.38	MSBW63-C6		1
PPA Coated Custom Length Strapping									
MSCW38T15-QR6	800	3560	.38	9.5	.015	.38	MSBW38-C6	BT1HT, BT2MS75	1
MSCW50T15-QR6	800	3560	.50	12.7	.015	.38	MSBW50-C6		1
MSCW63T15-QR6	800	3560	.63	15.9	.015	.38	MSBW63-C6		1

*Per SAE Standard AS23190/3 (formerly MIL). For additional details, refer to page F1.

**Base metal less coating

***Order number of reels required in multiples of Standard Package Quantity.

Custom Length Banding Dispenser System

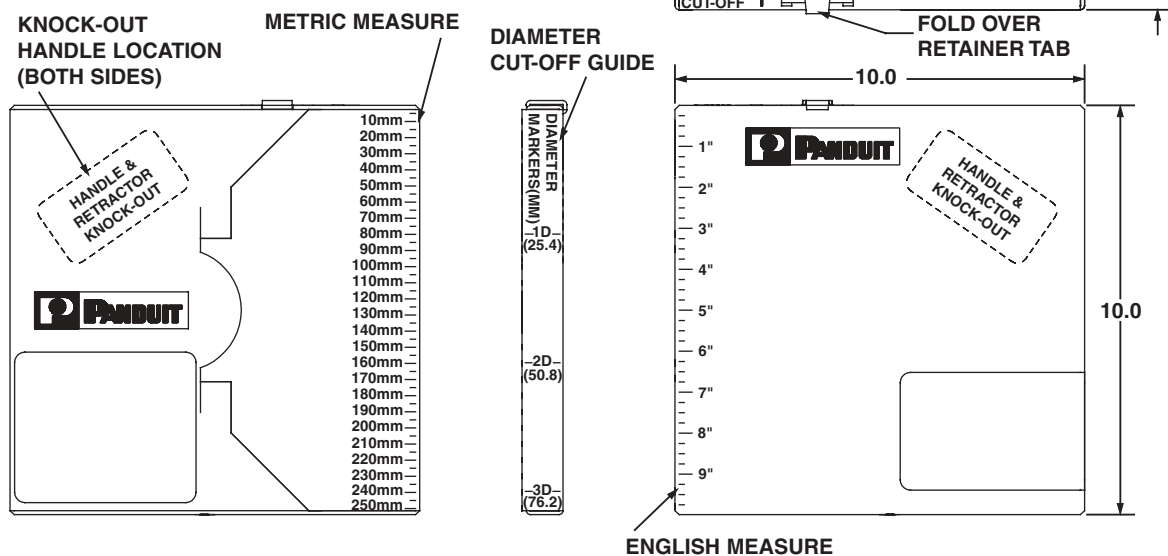

Buckles for Custom Length Strapping



- Buckle design provides a low finished profile
- After tensioning cut end is locked inside buckle

- No exposed sharp edge

Part Number	Material	Width		Part Description	Std. Pkg. Qty.	Std. Ctn. Qty.
		In.	mm			
MSBW50-C4	304	.50	12.7	Individual low profile buckles. To use, slip buckle onto strapping; turn back extended back approximately 2 in. (51 mm) to hold in place.	100	1000
MSBW38-C4	304	.38	9.5		100	1000
MSBW63-C4	304	.63	15.9		100	1000
MSBW38-C6	316	.38	9.5		100	1000
MSBW50-C6	316	.50	12.7		100	1000
MSBW63-C6	316	.63	15.9		100	1000

PANDUIT® PAN-STEEL® System FOR HARSH ENVIRONMENTS

Markets

PAN-STEEL® Nylon Coated Stainless Steel Strapping

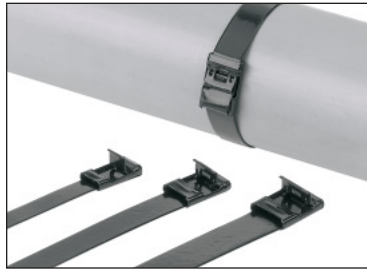

- The strength of steel, the protection of nylon; the nylon coating provides protection for the bundles
- Available in loop tensile strength up to 800 lbs. (3560N)
- Base metal is 316 grade stainless steel for excellent resistance to temperature extremes, corrosion, weather, chemicals, salt sprays and UV radiation

MLT Ties

Nylon 11 Coating

- 100% coated with Black Nylon 11, coating thickness .003 in. (.07 mm) / .005 in. (.13 mm) per side
- Halogen-free
- Good in applications at temperatures down to -40° F (-40° C)
- Excellent resistance to chemicals and salt sprays
- Upper temperature limit 285° F (140° C)

MS Strapping

Part Number	Max. Bundle Diameter		Length		Min. Loop Tensile Strength*		Min. Bundle Diameter		Width**		Thickness**		Recommended PANDUIT® Installation Tool	Std. Pkg. Qty.	Std. Ctn. Qty.
	In.	mm	In.	mm	Lbs.	N	In.	mm	In.	mm	In.	mm			
MSC4W38T15-L6	4.0	102	18.0	457	500	2225	1.0	25.4	.38	9.5	.015	.38	BT1HT, BT2MS75	50	250
MSC6W38T15-L6	6.0	152	24.4	620	500	2225	1.0	25.4	.38	9.5	.015	.38		50	250
MSC8W38T15-L6	8.0	203	30.7	780	500	2225	1.0	25.4	.38	9.5	.015	.38		50	250
MSC10W38T15-L6	10.0	254	37.0	940	500	2225	1.0	25.4	.38	9.5	.015	.38		50	250
MSC4W50T15-L6	4.0	102	18.0	457	500	3115	1.0	25.4	.50	12.7	.015	.38		50	250
MSC6W50T15-L6	6.0	152	24.4	620	500	3115	1.0	25.4	.50	12.7	.015	.38		50	250
MSC8W50T15-L6	8.0	203	30.7	780	500	3115	1.0	25.4	.50	12.7	.015	.38		50	250
MSC10W50T15-L6	10.0	254	37.0	940	500	3115	1.0	25.4	.50	12.7	.015	.38		50	250
MSC6W63T15-L6	6.0	152	24.4	620	800	3560	1.0	25.4	.63	15.9	.015	.38		50	250
MSC4W63T15-L6	4.0	102	18.0	457	800	3560	1.0	25.4	.63	15.9	.015	.38		50	250
MSC8W63T15-L6	8.0	203	30.7	780	800	3560	1.0	25.4	.63	15.9	.015	.38		50	250
MSC10W63T15-L6	10.0	254	37.0	940	800	3560	1.0	25.4	.63	15.9	.015	.38		50	250

*Per SAE Standard AS23190/3 (formerly MIL). For additional details, refer to [page F1](#).

** Base material before coating

Marking and ID

BT1HT Installation Tool for Strapping (MS Series)

Accessories



- Strap side entry (see photo)
- One or two hand tensioning with multi-position rear handle
- Adjustable tension control
- Lever actuated cut-off
- Easy removal of excess strap
- Installs all (3) sizes: 3/8 in. (9.5mm), 1/2 in. (12.7mm) and 5/8 in. (15.9mm)

Technical Info

Hand operated tool. Adjustable tension control and lever actuated cut-off.

Part Number	Part Description	Std. Pkg. Qty.
BT1HT	Installation tool. Used for all widths of PANDUIT® PAN-STEEL® strapping. Tensions, cuts strapping, and secures the buckle tab. Ratchet-type tool provides mechanical advantage for tensioning. Easy to operate.	1



Index

BT2MS75 Installation Tool for Strapping (MS Series)



BT2MS75

- Strap side entry (see photo)
- One or two hand tensioning with multi-position rear handle
- Lever actuated cut-off
- Easy removal of excess strap
- Installs all (3) sizes: 3/8 in. (9.5mm), 1/2 in. (12.7mm) and 5/8 in. (15.9mm)

Part Number	Part Description	Std. Pkg. Qty.
BT2MS75	Installation tool. Used for all widths of <i>PANDUIT® PAN-STEEL®</i> strapping. Tensions, cuts strapping, and secures the buckle tab. Allows one hand operation in otherwise difficult areas to install. Pliers-type tool provides mechanical advantage for tensioning. Easy to operate.	1
BT2N75	Replacement nose section for BT2MS75 tool. Provides the economy of repair vs. total tool replacement. Easy to install on tool.	1
KT2MG	Replacement tension gripper for BT2MS75 and ST2MT tool. Easy to install on tool. Can be part of a maintenance program. Extends life of tool.	1

Markets

MLT Ties

MS Strapping

Marking and ID

Accessories

Technical Info

Index

PAN-STEEL® System for Permanent Marking and Identification

The PAN-STEEL® System can be used to identify pipes, conduit, valves, cables and equipment in petrochemical plants, pulp and paper mills, refineries, offshore oil rigs and in many other harsh environments. It is designed to work with PANDUIT® MLT ties to provide the ultimate permanent identification solution.



- Long life
- Weather resistant
- Chemical resistant
- Temperature extremes
- Radiation resistant

PANDUIT® offers unique products to meet customer needs:

Custom laser marking — Sharp, crisp, high quality legends

Custom embossing — For rough and dirty applications

On-site marking devices — For quick and easy identification

Marker plates and tags — Sizes and styles for virtually all applications

Markets

Stainless Steel, Brass and Aluminum Marker Plates and Tags



- Identify pipes, conduit, valves, cables and equipment in petrochemical plants, pulp and paper mills, refineries, offshore oil rigs and in any other harsh environments
- All marker plates/tags can be custom marked by PANDUIT® with one of two computer controlled systems (laser or embosser) to provide permanent identification to resist corrosion, abrasion and radiation
- Use with PANDUIT® PAN-STEEL® Stainless Steel Cable Ties for fast installation at lowest installed cost

MLT Ties

Most tags are provided with one .25 in. (6.35mm) hole.

MS Strapping



Marking and ID

Accessories

Technical Info

Index

Part Number	Used with PAN-STEEL® Ties	Plate/Tag Size				Material	Thickness		Std. Pkg. Qty.	Std. Ctn. Qty.
		Width		Length			In.	mm		
		In.	mm	In.	mm					
MMP350-C	MLT-S	.75	19	3.50	89	304 Stainless Steel	.010	.25	100	1000
MMP350-C316	MLT-S	.75	19	3.50	89	316 Stainless Steel	.010	.25	100	1000
MMP350H-C	MLT-S/H	.75	19	3.50	89	304 Stainless Steel	.010	.25	100	1000
MMP350H-C316	MLT-S/H	.75	19	3.50	89	316 Stainless Steel	.010	.25	100	1000
MMP350W38-C	MLT-S	.38	10	3.50	89	304 Stainless Steel	.010	.25	100	1000
MMP350W38-C316	MLT-S	.38	10	3.50	89	316 Stainless Steel	.010	.25	100	1000
MMP172-C	MLT-S	.75	19	1.72	44	304 Stainless Steel	.010	.25	100	1000
MMP172-C316	MLT-S	.75	19	1.72	44	316 Stainless Steel	.010	.25	100	1000
MMP172W38-C	MLT-S	.38	10	1.72	44	304 Stainless Steel	.010	.25	100	1000
MMP172W38-C316	MLT-S	.38	10	1.72	44	316 Stainless Steel	.010	.25	100	1000
MT350-C	MLT-S	.75	19	3.50	89	304 Stainless Steel	.010	.25	100	1000
MT350-C316	MLT-S	.75	19	3.50	89	316 Stainless Steel	.010	.25	100	1000
MT350W38-C316	MLT-S	.38	10	3.50	89	316 Stainless Steel	.010	.25	100	1000
MT172-C	MLT-S	.75	19	1.72	44	304 Stainless Steel	.010	.25	100	1000
MT172-C316	MLT-S	.75	19	1.72	44	316 Stainless Steel	.010	.25	100	1000
MT172W38-C	MLT-S	.38	10	1.72	44	304 Stainless Steel	.010	.25	100	1000
MT338W21-Q	MLT-S	2.13	54	3.38	86	304 Stainless Steel	.015	.38	25	250
MTB338W21-Q	MLT-S	2.13	54	3.38	86	Brass	.015	.38	25	250
MT350W17-Q	MLT-S	1.73	44	3.50	89	304 Stainless Steel	.015	.38	25	250
MTB350W17-Q	MLT-S	1.73	44	3.50	89	Brass	.015	.38	25	250
MMP338W21-Q	MLT-S	2.13	54	3.38	86	304 Stainless Steel	.015	.38	25	250
MMPB338W21-Q	MLT-S	2.13	54	3.38	86	Brass	.015	.38	25	250
MMP350W17-Q	MLT-S	1.73	44	3.50	89	304 Stainless Steel	.015	.38	25	250
MT1D-Q	MLT-S	1.00 Circular	25	—	—	304 Stainless Steel	.035	.89	25	250
MTB1D-Q	MLT-S	1.00 Circular	25	—	—	Brass	.040	1.02	25	250
MT150D-Q	MLT-S	1.50 Circular	38	—	—	304 Stainless Steel	.035	.89	25	250
MTB150D-Q	MLT-S	1.50 Circular	38	—	—	Brass	.040	1.02	25	250
MT213D-Q	MLT-S	2.13 Circular	54	—	—	304 Stainless Steel	.015	.38	25	250
MTB213D-Q	MLT-S	2.13 Circular	54	—	—	Brass	.015	.38	25	250
AP350HW86-C	MLT-S/H*	.86	22	3.50	89	Aluminum	.015	.38	100	1000

*Galvanic reaction may occur between stainless steel ties and aluminum marker plates in certain environments causing the aluminum to corrode.

PAN-STEEL® Custom Marking Capabilities

Custom Marking Capabilities on PANDUIT® PAN-STEEL® Stainless Steel Cable Ties, Strapping, Metal Marker Plates/Tags and Anodized Aluminum Locks*

MLT Ties



PANDUIT® stainless steel cable ties, strapping, stainless steel, brass and aluminum marker plates/tags and anodized aluminum locks can be custom marked for identification of equipment, cables, hoses, pipes, conduit, etc. in petrochemical plants, power plants, pulp and paper mills, breweries, and many other applications. PANDUIT® in-house computer controlled custom marking systems provide sharp, crisp, high quality legends. Sequential numbering for serialization is available.

MS Strapping

* Anodized aluminum locks can only be marked by the laser system.

Marking and ID

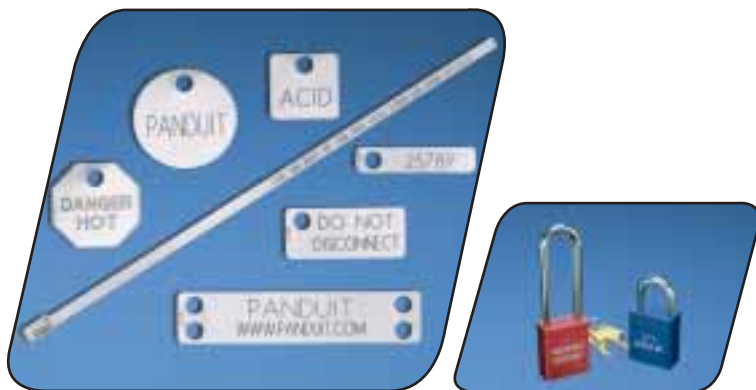

Accessories



Technical Info

LASER MARKING SYSTEM

- Used on all stainless steel cable ties, strapping, metal marker plates/tags and anodized aluminum locks
- BOLD block letters
- Upper and lower case character capability
- Alphanumeric and sequential numbering ability

Character Sizes** Available:

1/8 in. (3.18mm) 1/4 in. (6.35mm) 3/16 in. (4.77mm)
5/16 in. (7.94 mm) 1/2 in. (12.7 mm)

**Contact customer service for other available character sizes.

EMBOSSING SYSTEM

- Used on metal marker plates and tags which are a maximum of .020 in. (0.5 mm) thick
- Excellent for applications that are exposed to occasional painting and excessive dirt
- Upper case "raised" character capability only
- Alphanumeric and sequential numbering ability

Character Sizes** Available:

1/8 in (3.18 mm) 3/16 in. (4.77 mm)

Index

Markets

Metal Marking Devices

Metal Embossing Tape System



Used with PAN-STEEL® ties and accessories

- Embosses 3/16" (5mm) characters onto rolls of stainless steel or aluminum tape
- Excellent for on-site applications requiring quick, easy and permanent identification
- Can be used with PAN-STEEL® Stainless Steel Ties as a flag or a marker

MLT Ties

Part Number	Part Description	Std. Pkg. Qty.
-------------	------------------	----------------

Tool Kit

MEHT	Includes tool, carrying case, (1) roll each META (aluminum) and METS4 (stainless) tape. Characters Include: A B C D E F G H I J K L M N O P Q R S T U V W X Y Z 2 3 4 5 6 7 8 9 . /	1
-------------	--	---

MS Strapping



Used with PAN-STEEL® ties and accessories

Tape

META-X	.50" X 16' (12.7mm X 4.9m) aluminum tape*.	10**
METS3-X	.50" X 21' (12.7mm X 6.4m) 316 grade stainless steel tape.	10**
METS4-X	.50" X 21' (12.7mm X 6.4m) 304 grade stainless steel tape.	10**

* Galvanic reaction may occur between stainless steel ties and aluminum tape in certain environments causing the aluminum to corrode.

**Order number of rolls required in multiples of Standard Package Quantity.

Marking and ID



Tool punches a single 3/16" (5mm) diameter hole (For Std. Cross section tie) or a series of holes for wider cross-section sizes.

Indenter Press



Easy-to-operate manual indenter press. Interchangeable indenter wheels in three character sizes are available.

- For identification in various environments
- Provides quick easy and permanent identification of PANDUIT® PAN-STEEL® Stainless Steel Cable Ties, Straps, Marker Plates, and Tags
- Interchangeable wheels
- Press includes fixture to hold MMP350 series marker plates, MLT series cable ties, and MS strapping in place to provide high quality marking
- Tool is designed for long life and durability
- Automatic table indexing
- Depth adjustment screw

Accessories

Part Number	Part Description	Std. Pkg. Qty.
-------------	------------------	----------------

Press

IMP094	Indenter press with 3/32" (2.38mm) character wheel.	1
IMP125	Indenter press with 1/8" (3.18mm) character wheel.	1
IMP187	Indenter press with 3/16" (4.77mm) character wheel.	1

Interchangeable Wheel Kits

MWK094	3/32" (2.38mm) character wheel kit (wheel and indexing gear).	1
MWK125	1/8" (3.18mm) character wheel kit (wheel and indexing gear).	1
MWK187	3/16" (4.77mm) character wheel kit (wheel and indexing gear).	1
IMP-FIX	Interchangeable fixture for MMP172, MMP338, MT Series, and the aluminum marker plates.	1

Technical Info

Index

Marker Stamp Kit



The impression is made by hitting the holder with a hammer.

- Provides quick, easy and permanent identification of PANDUIT® PAN-STEEL® Stainless Steel Cable Ties, Straps, Marker Plates and Tags

Part Number	Part Description	Std. Pkg. Qty.
STK12	Marker stamp kit contains (100) character stamps, (1) holder and (1) carrying case. High quality 1/8" (3.18mm) nom. size steel character. Type holder keeps type aligned and provides uniform depth of impression. The holder takes up to 9 characters - 1 1/8" (28.6mm) long.	1

MLT Ties

Characters include:

A A A B B C C D D E E E F F G G H H I I J J K K L L L M M N N N O O O
P P Q R R R S S S T T U U U V V W W X X Y Z & / / - - . . , , 1 1 1 1 2 2 2 2 3 3 3
4 4 4 4 5 5 5 6 6 6 7 7 7 8 8 8 9 9 0 0 0

MS
Strapping

KP-515 Design Kit



- Perfect for proto-typing
- Durable and lightweight
- Convenient and handy plastic kit box; once closed parts stay in their compartments

Part Number	Part Description	Std. Pkg. Qty.
KP-515	Contains: (100) MLT2S ties (100) MLT2H ties (50) MMP350H marker plates (10) PCSS-5 in. (12.7 cm) length cushion sleeve (10) PCSH-5 in. (12.7 cm) length cushion sleeve (1) HTMT installation tool (1) K-505 plastic kit box	1

Marking
and
ID

Accessories

Technical
Info

Index

PAN-STEEL® System Accessories

PAN-STEEL® System Accessories are used with PAN-STEEL® Stainless Steel Cable Ties to speed and simplify the mounting of wires, cables and tubing. Installation methods include screw mounts and push mounts.



- High strength
- Long life
- Weather resistant
- Chemical resistant
- Temperature extremes
- Radiation resistant
- Easy to use

PANDUIT® offers unique products to meet customer needs:

Screw mounts — One hole mounting

Push mount — No tapping required

Bulk head mount — Zero profile mounting

Stackable spacers — For aerial lashing applications

PANDUIT® PAN-STEEL® System FOR HARSH ENVIRONMENTS

Markets

MTM1H Stainless Steel Tie Mount

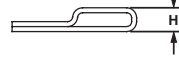
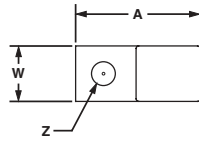

- Low profile
- One hole mounting
- For use with standard, light-heavy and heavy cross section PAN-STEEL® ties as well as .375" (9.5mm) wide strapping
- 304 Stainless Steel

MLT Ties

Part Number	Used with PAN-STEEL® Ties/Strapping	Mounting Method*	Length A		Width W		Height H		Hole Diameter Z		Std. Pkg. Qty.	Std. Ctn. Qty.
			In.	mm	In.	mm	In.	mm	In.	mm		
MTM1H-C	MLTS/LH/H, MS375 or MSC375	#8 (4.0mm) screw	.90	22.6	.40	10.2	.17	4.4	.17	4.4	100	1000
MTM1H10-C	MLTS/LH/H, MS375 or MSC375	#10 (5.0mm) screw	.90	22.6	.40	10.2	.17	4.4	.21	5.4	100	1000
MTM1H25-C	MLTS/LH/H, MS375 or MSC375	1/4" (6 mm) screw	.90	22.6	.40	10.2	.17	4.4	.28	7.1	100	1000

*Stainless steel screws are recommended for fastening to avoid corrosion problems associated with dissimilar metals.

MS Strapping

Stainless Steel Push Mount

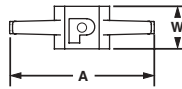

- No tapping required
- Used where only one side of the panel is accessible
- Nothing to assemble
- For use with standard, light-heavy and heavy cross section PAN-STEEL® ties
- 304 Stainless Steel

Marking and ID

Part Number	Used with PAN-STEEL® Ties/Strapping	Mounting Method	Length A		Width W		Height H		Panel Thickness P		Std. Pkg. Qty.	Std. Ctn. Qty.
			In.	mm	In.	mm	In.	mm	In.	mm		
MPWM-H56-Q	MLTS/LH/H	Inserted into pre-drilled hole 5/16 in. (8 mm).	.98	24.7	.29	7.3	.56	14.2	.031 – .094	0.8 – 2.4	25	250

Accessories

Stainless Steel Push Button Mount

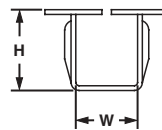
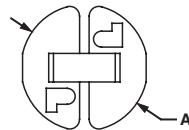

- Low profile
- No tapping required
- Designed for use only where both sides of the panel are accessible
- For use with standard cross section PAN-STEEL® ties
- 304 Stainless Steel

Technical Info

Part Number	Used with PAN-STEEL® Ties/Strapping	Mounting Method	Diameter D		Width W		Height H		Panel Thickness		Std. Pkg. Qty.	Std. Ctn. Qty.
			In.	mm	In.	mm	In.	mm	In.	mm		
MBM-H25-Q	MLT-S	Inserted into pre-drilled hole .25 in. (6.4mm).	.40	10.0	.20	5.0	.26	6.5	.03 – .13	.8 – 4.0	25	250

Index

Stainless Steel 2-Way Mount

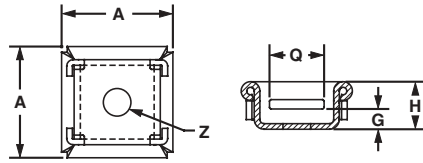
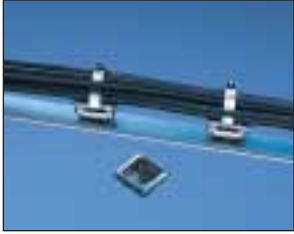

- Two-way mount allows stainless steel cable ties to be inserted from either of two sides
- Low profile
- Single hole center mounting for maximum holding and stability
- Maximum screw head height .09 (2.3mm)
- For use with standard, light-heavy and heavy cross section PAN-STEEL® ties
- 304 Stainless Steel

Part Number	Used with PAN-STEEL® Ties/Strapping	Mounting Method*	Length A		Height H		Screw Head Height G		Slot Width Q		Hole Diameter Z		Std. Pkg. Qty.	Std. Ctn. Qty.
			In.	mm	In.	mm	In.	mm	In.	mm	In.	mm		
MTM2H-Q	MLTS/LH/H	#8 (4 mm) screw	.71	18.0	.30	8.0	.09	2.3	.35	9.0	.17	4.5	25	250

*Stainless steel screws are recommended for fastening to avoid corrosion problems associated with dissimilar metals.

Stainless Steel Bulkhead Mount

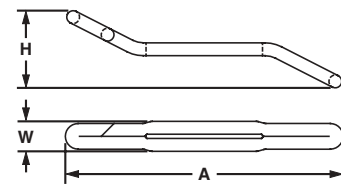

- Zero profile
- Mounts directly to surface
- Used where only one side of the panel is accessible
- Permanent, secure application
- Used with standard, light-heavy and heavy cross section PAN-STEEL® ties
- 304 Stainless Steel

Part Number	Used with PAN-STEEL® Ties/Strapping	Mounting Method	Length A		Width W		Height H		Max. Panel Thickness		Std. Pkg. Qty.	Std. Ctn. Qty.
			In.	mm	In.	mm	In.	mm	In.	mm		
MTMBH-Q	MLTS/LH/H	Pre-drill hole size Standard and Light Heavy cross section MLT-S/LH .375 (9.5) – .500 (12.7) Heavy cross section MLT-H .500 (12.7) – .625 (15.9)	1.92	48.5	.21	5.3	.54	13.7	.50	12.7	25	250

To Install Bulkhead Mount:

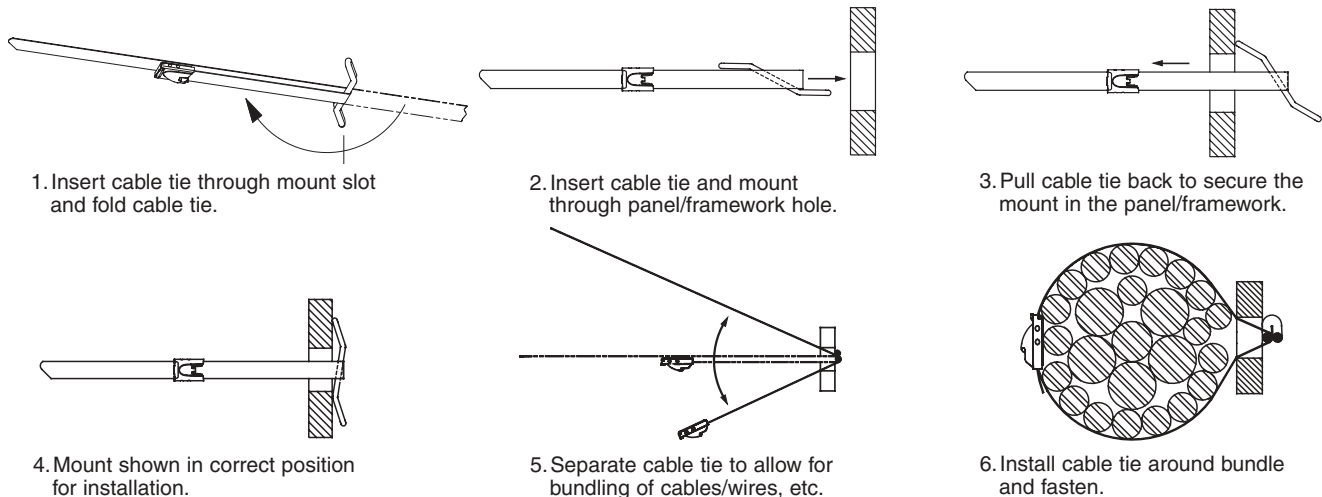

PANDUIT® PAN-STEEL® System FOR HARSH ENVIRONMENTS

Markets

Stackable Aerial Cable Spacer

MLT Ties



- Just one part to inventory
- Spacer snaps by hand into another to increase spacer height by .50 in. (12.7mm) increments

- Only one part, on-site sorting is eliminated
- Used with cable ties up to .75 in. (19mm) wide in parallel or perpendicular applications

MS Strapping



Stackable Spacers (SACS50-T100) and Stainless Steel Ties (MLT4H-LP).

PANDUIT® cable ties and spacers are used to separate the support strand from the cable or to separate two cables in aerial lashing applications.

Marking and ID

Part Number	Used with Cable Ties	Dimensions						Material	Color	Environment	Mounting Method	Std. Pkg. Qty.	Std. Ctn. Qty.
		A		B		C							
		In.	mm	In.	mm	In.	mm						
SACS50-T100	▲ See Footnote	2.08	52.8	1.16	29.5	.50	12.7	Weather Resistant Polypropylene	Black	Outdoors	Cable Ties	200	2000

▲ Stackable spacers may be installed using stainless steel cable ties or weather resistant cable ties (see Cable Ties & Wiring Accessories Catalog SA-CTCB03).

Accessories

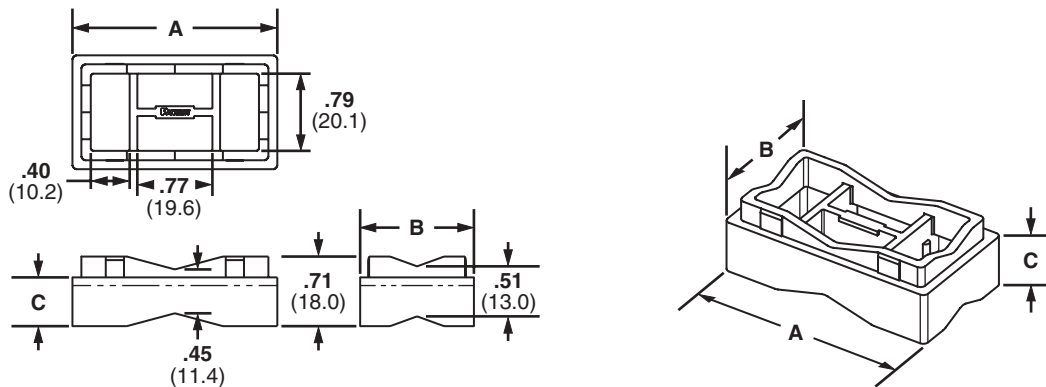

Technical Info

Index

Stainless Steel Tie Technical Information

Physical Characteristics of Stainless Steel Cable Ties (MLT Series)

PAN-STEEL®	Stainless Steel
Tensile Strength 73° F (23° C)	90,000* PSI
Color	Stainless
Flammability	Non-flammable
Radiation Resistance	2 X 10 ⁸ Rads
Water Absorption	None

PAN-STEEL®	Stainless Steel
Max. Continuous Use Temperature	1000° F (538° C) for 304 & 316 material
Min. Continuous Use Temperature	-112° F (-80° C) for 304 & 316
Ultraviolet Light Resistance	Excellent

* ASTM E8 Test Method

MLT Ties

PANDUIT® Stainless Steel Cable Tie and Strapping Approvals

AGENCY	SPEC / APPROVAL	REQUIREMENT	APPLICABLE PRODUCTS	AGENCY	SPEC / APPROVAL	REQUIREMENT	APPLICABLE PRODUCTS
SAE Int'l formerly US MIL	AS23190 formerly MS23109E	Dimensional, visual, vibration, temp. cycling, immersion, melting point	MLT-S & MLT-H Series and heavy cable ties in both 304 & 316 material	Underwriters Laboratories	E56854	Dimensional, tensile, temp., cycling, humidity	MLT-S, MLT-H, MLT-WS, & MLTWH in 304, 316, and 321 material
Det Norske Veritas	Cert. #E-6540 #E-6539	Salt mist test, tensile test, accelerated aging, vibration tests	MLT-S, MLT-H & MS ties and straps in 316 material	Germanischer Lloyd	Cert. #32666- 83HH51796- 89HH	Mechanical	All MLT Ties and MS Straps
Amer. Bureau of Shipping	Cert. #99-CH18282-X	Mechanical	MLT-S, MLT-H, MLT-H in both 304 & 316 material and MLTC in 316 material	US Coast Guard	File No.16703/46	Mechanical	MLT-H Series Cable Ties
Lloyd's Register of Shipping	Cert. #89/60123(E2)	Material specification, tensile test, vibration tests	All MLT & MS ties and straps in both 304 and 316 material	US Military	MIL-T-81306A MS90387-3	Mechanical	GS4MT Installation tools
Bureau Veritas	Cert. #04048/CIB	Material specification, dimensional, visual	MLT-S, MLT-H in 316 material	RINA	Cert. #ELE71502CS	Mechanical	All MLT ties

 MS
Strapping

 Marking
and
ID

Accessories

Approvals



Military Specification
MIL-S-23190E



E56854



Cert. 99CH18282-X



United States
Coast Guard



Bureau
Veritas



Det Norske
Veritas



Lloyd's Register
of Shipping

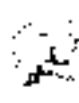

Germanischer
Lloyd



RINA

 Technical
Info

Index

Markets

Chemical Resistance at 70° F (21° C) Temperature

	304 & 316 Stainless Steel*		304 & 316 Stainless Steel*		304 & 316 Stainless Steel*		304 & 316 Stainless Steel*					
	Chemical	%	Chemical	%	Chemical	%	Chemical	%				
MLT Ties	Arsenic Acid	40	E	Cider	E	Methyl Alcohol	100	E	Sodium Bisulfate	10	E	
	Acetone	100	E	Diochloroethane	100	E	Methyl Chloride	100	E	Sodium Borate	All	E
	Aluminum Hydroxide	AQ C.S.	E	Diethyl Ether	100	E	Methyl Ethyl Ketone	100	E	Sodium Carbonate	5	E
	Ammonium Carbonate	5	E	Ethyl Alcohol	100	E	Naphtha	100	E	Sodium Chlorate	25	E
	Ammonium Hydroxide	10	E	Ethyl Chloride	100	E	Nitric Acid	30-70	E	Sodium Chloride	2	E
	Ammonium Nitrate		E	Ethyl Glycol	100	E	Nitrous Acid	5	E	Sodium Fluoride	5	F
	Ammonium Sulfate	10	S	Ferric Hydroxide	All	E	Oleic Acid	100	E	Sodium Hydroxide	10	E
	Barium Carbonate	All	E	Ferric Nitrate	10	E	Oxalic Acid	10	E	Sodium Hyposulfite	AQ C.S.	E
	Barium Chloride	5	E	Ferrous Sulfate	10	E	Paraffin	100	E	Sodium Nitrate	5	E
	Barium Sulfate	10	E	Fuel Oil	100	E	Petroleum Ether	100	E	Sodium Nitrite	AQ C.S.	E
MS Strapping	Barium Sulfide	10	E	Furfural	100	E	Phenol	90	E	Sodium Perchlorate	10	E
	Benzene	100	E	Gallic Acid	AQ C.S.	E	Phosphoric Acid	10	E	Sodium Phosphate	5	E
	Benzoic Acid	100	E	Gasoline	100	E	Picric Acid	1	S	Sodium Sulfate	5	E
	Butyric Acid	50	E	Glycerine	100	E	Potassium Bromide	AQ C.S.	S	Sodium Thiosulfate	5	S
	Calcium Carbonate	AQ C.S.	E	Hydrocyanic Acid	All	E	Potassium Carbonate 1%		E	Stearic Acid	100	E
	Calcium Chlorate	10	E	Hydrogen Peroxide	30	E	Potassium Chlorate	AQ C.S.	E	Sulfur	100	E
	Calcium Hydroxide	20	E	Hydrogen Sulfide	Dry	E	Potassium Dichromate	40	E	Sulfur Dioxide	All	E
	Calcium Hydrochlorite	2	F	Idoform	100	E	Potassium Ferrocyanide	25	E	Sulfuric Acid	100	E
	Calcium Sulfate	2	E	Isopropyl Alcohol	100	E	Potassium hydroxide	5	E	Sulfuric Acid	5	F
	Marking and ID	Carbon Tetrachloride			Jet Fuel	100	E	Potassium Iodide	All	E	Tannic Acid	10
Chlorine (Wet)			F	Lactic Acid	100	E	Potassium Nitrate	50	E	Tartaric Acid	50	E
Chlorine (Dry)			F	Lanolin	10	E	Potassium Permanganate	5	E	Tetrahydrofuran	100	E
Chloroacetic Acid		30	F	Lead Acetate	5	E	Potassium Sulfate	5	E	Toluene	100	F
Chloroform		100	E	Magnesium Carbonate	All	E	Potassium Sulfide	AQ C.S.	E	Xylene	100	E
Chromic Acid		5	E	Magnesium Chloride	10	F	Propyl Alcohol	100	E	Zinc Chloride	70	E
Citric Acid		50	E	Magnesium Nitrate	All	E	Silver Nitrate	10	E	Zinc Nitrate	AQ C.S.	E
Copper Cyanide		10	E	Malic Acid	AQ C.S.	E	Sodium Acetate	60	E	Zinc Sulfate	AQ C.S.	E
Copper Nitrate		50	E	Mercury	100	E	Sodium Bicarbonate	All	E			

* E = Excellent S = Satisfactory F = Fair AQ C.S. = Aqueous Cold Saturated All = All % Concentrations

Technical Info

Rigorous Tests and Physical Properties of Stainless Steel Ties

STRENGTH: PANDUIT® PAN-STEEL® Stainless Steel Ties are tested per the U.S. Military Specification MIL-S-23190, minimum loop tensile test. This test consists of applying a tie to a split mandrel and then measuring the force required to separate the (2) halves until the tie fails. These minimum loop tensile strengths are given for the various products on [pages B4 through B6](#).

TEMPERATURE EXTREMES: PANDUIT® PAN-STEEL® Stainless Steel Ties are 100% stainless steel in the alloy provided (locking head, locking ball and body all provided from the same grade of material ordered).

Various temperature tests have been successfully completed. One such test is the U.S. Military Temperature Cycling Test per Thermal Shock Method 107, Test Condition B of MIL-STD-202F. This test exposes the parts from low temperature -85° F (-65°C) to high temperature 275° F (135°C) to low temperature -85° F (-65°C). After exposure, the parts must be free of cracks, distortions, breaks, release of locking device, and meet the minimum loop tensile requirements.

VIBRATION: PANDUIT® PAN-STEEL® standard cross section ties have passed the U.S. Military random vibration Test Method 214. Test Condition II, Letter J of MIL-STD-202. This test consists of applying parts to a bundle and then vibrating them with random vibration for 8 hours in each of two mutually perpendicular directions. The parts are then subjected to further temperature testing and finally have to pass the minimum loop tensile strength test.



Index

Rigorous Tests and Physical Properties of Stainless Steel Ties (continued)

SALT SPRAY: PANDUIT® PAN-STEEL® Stainless Steel Ties have been subjected to salt spray tests without signs of corrosion or reduction in performance.

OUTDOOR EXPOSURE: PANDUIT® PAN-STEEL® Stainless Steel Ties have been exposed outdoors at New Lenox, Illinois USA since 1985. At the printing of this catalog, there has been no sign of corrosion or loss of performance.

FLUID IMMERSION: PANDUIT® PAN-STEEL® Stainless Steel Ties were immersed in: 1-Hydraulic Fluid, 2-Turbine Fuel, 3-Lubricating Oil, and 4-Isopropyl Alcohol for (4) hours at temperatures of 122° F (50° C). Per SAE Standard AS23190/3, the parts were then subjected to and passed the minimum loop tensile test.

RADIATION: Installed cable ties of various materials have been exposed to different amounts of radiation to determine the maximum acceptable limit. These tests were conducted by PANDUIT® to determine the acceptability for use in various areas of nuclear power plants (accumulated over 40 year life). Radiation resistance is 2x10⁸ rads.

Military Cross Reference (AS23190)	
PANDUIT® Part Number	Current Military Standard Part Number
MLT2S-CP	AS23190/3-1
MLT2S-CP316	AS23190/3-1
MLT4S-CP	AS23190/3-2
MLT4S-CP316	AS23190/3-2
MLT6S-CP	AS23190/3-3
MLT6S-CP316	AS23190/3-3
MLT8S-CP	AS23190/3-4
MLT8S-CP316	AS23190/3-4
MLT2H-LP	AS23190/3-5
MLT2H-LP316	AS23190/3-5
MLT4H-LP	AS23190/3-6
MLT4H-LP316	AS23190/3-6
MLT6H-LP	AS23190/3-7
MLT6H-LP316	AS23190/3-7
MLT8H-LP	AS23190/3-8
MLT8H-LP316	AS23190/3-8
MLT10H-LP	AS23190/3-9
MLT10H-LP316	AS23190/3-9

Gage Conversion Chart		
Gage	Inches	mm
10	.135	3.571
11	.120	3.175
12	.105	2.778
13	.090	2.381
14	.075	1.984
15	.067	1.778
16	.060	1.587
17	.054	1.422
18	.048	1.270
19	.042	1.118
20	.036	0.965
21	.033	0.865
22	.030	0.793
23	.027	0.711
24	.024	0.635
25	.021	0.559
26	.018	0.483
27	.016	0.432
28	.015	0.396
29	.014	0.356
30	.012	0.330
31	.011	0.279
32	.010	0.254
33	.009	0.229
34	.008	0.216

PANDUIT® PAN-STEEL® System

FOR HARSH ENVIRONMENTS

Markets

Part Number	Page Number
A	
AP350HW86-C	D2
B	
BT1HT	C6
BT2MS75	C7
BT2N75	C7
C	
CAMT	B13
G	
GS4MT	B13
H	
HTMT	B14
I	
IMP-FIX	D4
IMP094	D4
IMP125	D4
IMP187	D4
K	
K4M-BLD	B13
K4MTG	B13
KP-515	D5
KPPTMTB	B12
KPPTMTG	B12
KT2MG	C7
KT3MG	B14
M	
MBCEH-QR316	B7
MBCH-QR316	B7
MBCSH-QR316	B7
MBEH-TLR	B7
MBEH-TLR316	B7
MBH-MR	B7
MBH-MR316	B7
MBH-TLR	B7
MBH-TLR316	B7
MBM-H25-Q	E2
MBS-MR	B7
MBS-MR316	B7
MBS-TLR	B7
MBS-TLR316	B7
MBSH-TR	B7
MBSH-TR316	B7
MEHT	D4
META-X	D4
METS3-X	D4
METS4-X	D4
MLT10EH-LP	B4
MLT10EH15-LP	B4
MLT10H-LP	B4
MLT10H-LP316	B5
MLT10S-CP	B4
MLT10S-CP316	B5

Part Number	Page Number
MLT10SH-LP	B5
MLT10WH-LP	B6
MLT12EH-Q	B4
MLT12EH15-Q	B4
MLT12H-Q	B4
MLT12S-Q	B4
MLT12SH-Q	B5
MLT14H-Q	B4
MLT14S-Q	B4
MLT15S-Q	B4
MLT1S-CP	B4
MLT1S-CP316	B5
MLT2.7H-LP	B4
MLT2.7S-CP	B4
MLT2.7WH-LP	B6
MLT2.7WH-LP316	B6
MLT2.7WLH-LP	B6
MLT2.7WLH-LP316	B6
MLT2.7WS-LP	B6
MLT2.7WS-LP316	B6
MLT2DH-L	B11
MLT2EH-LP	B4
MLT2EH-LP316	B5
MLT2H-LP	B4
MLT2H-LP316	B5
MLT2LH-LP	B4
MLT2LH-LP316	B5
MLT2S-CP	B4
MLT2S-CP316	B5
MLT2S-L	B4
MLT4DEH-Q	B11
MLT4DEH-Q316	B11
MLT4DEH15-Q	B11
MLT4DEH15-Q316	B11
MLT4DH-L	B11
MLT4DSH-Q	B11
MLT4DSH-Q316	B11
MLT4EH-LP	B4
MLT4EH-LP316	B5
MLT4EH15-LP	B4
MLT4EH15-LP316	B5
MLT4H-LP	B4
MLT4H-LP316	B5
MLT4LH-LP	B4
MLT4LH-LP316	B5
MLT4S-CP	B4
MLT4S-CP316	B5
MLT4S-L	B4
MLT4SH-LP	B5
MLT4SH-LP316	B5
MLT4WH-LP	B6
MLT4WH-LP316	B6
MLT4WLH-LP	B6

MLT Ties

MS Strapping

Marking and ID

Accessories

Technical Info

Index

PANDUIT® PAN-STEEL® System

FOR HARSH ENVIRONMENTS

Markets

Part Number	Page Number
-------------	-------------

Part Number	Page Number
-------------	-------------

MLT Ties

MLT4WLH-LP316	.B6
MLT4WS-LP	.B6
MLT4WS-LP316	.B6
MLT5DH-L	.B11
MLT6DEH-Q	.B11
MLT6DEH-Q316	.B11
MLT6DEH15-Q	.B11
MLT6DEH15-Q316	.B11
MLT6DSH-Q	.B11
MLT6DSH-Q316	.B11

MLTC4H-LP316	.B9
MLTC6H-LP316	.B9
MLTC8H-LP316	.B9
MLTFC2EH-LP316	.B9
MLTFC2H-LP316	.B9
MLTFC2LH-LP316	.B9
MLTFC2S-CP316	.B9
MLTFC4EH-LP316	.B9
MLTFC4H-LP316	.B9
MLTFC4LH-LP316	.B9

MS Strapping

MLT6EH-LP	.B4
MLT6EH-LP316	.B5
MLT6EH15-LP	.B4
MLT6EH15-LP316	.B5
MLT6H-LP	.B4
MLT6H-LP316	.B5
MLT6LH-LP	.B4
MLT6LH-LP316	.B5
MLT6S-CP	.B4
MLT6S-CP316	.B5

MLTFC4S-CP316	.B9
MLTFC6EH-LP316	.B9
MLTFC6H-LP316	.B9
MLTFC6LH-LP316	.B9
MLTFC6S-CP316	.B9
MLTFC8EH-LP316	.B9
MLTFC8H-LP316	.B9
MLTFC8LH-LP316	.B9
MLTFC8S-CP316	.B9

Marking and ID

MLT6SH-LP	.B5
MLT6SH-LP316	.B5
MLT6WH-LP	.B6
MLT6WH-LP316	.B6
MLT6WLH-LP	.B6
MLT6WLH-LP316	.B6
MLT6WS-LP	.B6
MLT6WS-LP316	.B6

MMP172-C	.D2
MMP172-C316	.D2
MMP172W38-C	.D2
MMP172W38-C316	.D2
MMP338W21-Q	.D2
MMP350-C	.D2
MMP350-C316	.D2
MMP350H-C	.D2
MMP350H-C316	.D2

Accessories

MLT8DEH-Q	.B11
MLT8DEH-Q316	.B11
MLT8DEH15-Q	.B11
MLT8DEH15-Q316	.B11
MLT8DSH-Q	.B11
MLT8DSH-Q316	.B11
MLT8EH-LP	.B4
MLT8EH-LP316	.B5
MLT8EH15-LP	.B4
MLT8EH15-LP316	.B5

MMP350W17-Q	.D2
MMP350W38-C	.D2
MMP350W38-C316	.D2
MMPB338W21-Q	.D2
MPWM-H56-Q	.E2
MS10W38T15-L4	.C4
MS10W38T15-L6	.C4
MS10W50T15-L4	.C4
MS10W50T15-L6	.C4

Technical Info

MLT8H-LP	.B4
MLT8H-LP316	.B5
MLT8LH-LP	.B4
MLT8LH-LP316	.B5
MLT8S-CP	.B4
MLT8S-CP316	.B5
MLT8SH-LP	.B5
MLT8SH-LP316	.B5

MS10W63T15-L4	.C4
MS10W63T15-L6	.C4
MS2W38T15-L4	.C4
MS2W38T15-L6	.C4
MS4W38T15-L4	.C4
MS4W38T15-L6	.C4
MS4W50T15-L4	.C4
MS4W50T15-L6	.C4
MS4W63T15-L4	.C4
MS4W63T15-L6	.C4

Index

MLT8WH-LP	.B6
MLT8WH-LP316	.B6
MLT8WLH-LP	.B6
MLT8WLH-LP316	.B6
MLT8WS-LP	.B6
MLT8WS-LP316	.B6
MLTC10H-LP316	.B9
MLTC2H-LP316	.B9

MS6W38T15-L4	.C4
MS6W38T15-L6	.C4
MS6W50T15-L4	.C4
MS6W50T15-L6	.C4
MS6W63T15-L4	.C4
MS6W63T15-L6	.C4
MS8W38T15-L4	.C4

PANDUIT® PAN-STEEL® System

FOR HARSH ENVIRONMENTS

Markets

Part Number	Page Number
MS8W38T15-L6	.C4
MS8W50T15-L4	.C4
MS8W50T15-L6	.C4
MS8W63T15-L4	.C4
MS8W63T15-L6	.C4
MSBW38-C4	.C5
MSBW38-C6	.C5
MSBW50-C4	.C5
MSBW50-C6	.C5
MSBW63-C4	.C5
MSBW63-C6	.C5
MSC10W38T15-L6	.C6
MSC10W50T15-L6	.C6
MSC10W63T15-L6	.C6
MSC4W38T15-L6	.C6
MSC4W50T15-L6	.C6
MSC4W63T15-L6	.C6
MSC6W38T15-L6	.C6
MSC6W50T15-L6	.C6
MSC6W63T15-L6	.C6
MSC8W38T15-L6	.C6
MSC8W50T15-L6	.C6
MSC8W63T15-L6	.C6
MSCNW38T15-QR6	.C5
MSCNW50T15-QR6	.C5
MSCNW63T15-QR6	.C5
MSCW38T15-QR6	.C5
MSCW50T15-QR6	.C5
MSCW63T15-QR6	.C5
MSW38T15-CR4	.C5
MSW38T15-CR6	.C5
MSW50T15-CR4	.C5
MSW50T15-CR6	.C5
MSW63T15-CR4	.C5
MSW63T15-CR6	.C5
MT150D-Q	.D2
MT172-C	.D2
MT172-C316	.D2
MT172W38-C	.D2
MT1D-Q	.D2
MT213D-Q	.D2
MT338W21-Q	.D2
MT350-C	.D2
MT350-C316	.D2
MT350W17-Q	.D2
MT350W38-C316	.D2
MTB150D-Q	.D2
MTB1D-Q	.D2
MTB213D-Q	.D2
MTB338W21-Q	.D2
MTB350W17-Q	.D2
MTHEH-C	.B8
MTHEH-C316	.B8
MTHH-C	.B8

Part Number	Page Number
MTHH-C316	.B8
MTHS-C	.B8
MTHS-C316	.B8
MTHSH-C	.B8
MTHSH-C316	.B8
MTM1H-C	.E2
MTM1H10-C	.E2
MTM1H25-C	.E2
MTM2H-Q	.E3
MTMBH-Q	.E3
MWK094	.D4
MWK125	.D4
MWK187	.D4
P	
PCSH-CR	.B10
PCSS-CR	.B10
PL289N1	.B12
PPH10	.B12
PPTMT	.B12
R	
RT1HT	.B14
S	
SACS50-T100	.E4
ST3MT	.B14
STK12	.D5
T	
TTLK3	.B13

MLT Ties

MS Strapping

Marking and ID

Accessories

Technical Info

Index

PANDUIT® is a global leader in wiring and communication products, delivering end-to-end solutions in support of demanding electrical and networking requirements.

PANDUIT® Catalogs

Cable Ties

SA-CTCB03

- PAN-TY® Cable Ties
- PAN-TY® Clamp Ties
- PAN-TY® Push Mount Ties
- PAN-TY® Marker Ties
- DOME-TOP® Barb Ty Cable Ties
- DOME-TOP® Barb Ty Clamp Ties
- DOME-TOP® Barb Ty Marker Ties
- CONTOUR-TY™ Cable Ties
- DURA-TY™ Cable Ties
- BELT-TY™ In-Line Cable Ties
- TAK-TY® Hook & Loop Cable Ties
- STA-STRAP® Cable Ties
- Cable Tie Installation Tools
- Custom Hot Stamping

Wiring Accessories/Insulation

SA-CTCB03

- Adhesive Backed Cable Tie Mounts
- Screw Applied Cable Tie Mounts
- Flat Cable Mounts
- Fixed Diameter Clamps
- Harness Board Accessories
- Spiral Wrap
- Grommet Edging
- Braided Expandable Sleeving
- Corrugated Loom Tubing and Fittings
- Heat Shrink Tubing
- Non-Shrink PVC Tubing
- PAN-WRAP™ Split Harness Wrap

Identification Products

SA-101N315C-ID

- Hand-Held Printers
- Tabletop Printers
- Labeling Software
- Computer Printable Labels
- Wire Markers
- Lockout/Tagout Products
- Voltage Markers
- Warning Labels
- Safety Signs and Tags
- Letters and Numbers

Terminals

SA-TM03CB02A

- PAN-TERM® Terminals
- Ferrule End Sleeves
- PAN-TERM® Disconnects
- PAN-TERM® Splices
- PAN-TERM® Wire Joints
- Terminal Kits
- Ferrule End Sleeve Kits
- REEL SMART™ Terminal Products
- Terminal Installation Tools

Power Connectors

SA101N15C-NL

- Copper Compression Lugs
- Copper Compression Splices
- High Voltage Lugs and Splices
- Compression Taps
- Aluminum Compression Lugs
- Aluminum Compression Splices
- Compression Connector Accessories
- Copper Mechanical Connectors
- Split Bolt Connectors
- Aluminum Mechanical Connectors - Dual Rated Connectors
- Grounding Connectors
- Crimping Tools and Dies

Wiring Duct

SA-WDCB05

- PANDUCT® Slotted Wall Wiring Duct
- PANDUCT® Solid Wall Raceway
- PANDUCT® Halogen Free Slotted Wall Wiring Duct
- PANDUCT® Flush Cover Round Hole Wiring Duct
- PANDUCT® Hinged Slotted Wall Wiring Duct
- PANDUCT® Flexible Wiring Duct
- PANDUCT® Low Smoke Slotted Wall Wiring Duct
- Wiring Duct Accessories and Installation Tools

Surface Raceway

SA-SRCB02

- Office Furniture Raceway
- Cove Raceway
- PAN-WAY® TG-70 Surface Raceway
- PAN-WAY® T-70 & Twin-70 Surface Raceway
- PAN-WAY® T-45 Surface Raceway
- ULTIMATE ID™ Network Labeling System
- Faceplates, Surface Mount Outlet Boxes & Labeling Administration
- PAN-WAY® LD Profile Surface Raceway
- PAN-WAY® T130 Surface Raceway
- PAN-POLE™ Outlet Poles

Network Connectivity

SA-NCCB04

- Modules
- ULTIMATE ID™ System
- Work Area
- Zone Cabling
- Patch Panels, Copper Patch Cords & Punchdowns
- Fiber Connectors, Enclosures & Patch Cords
- Racks & Cable Management
- Grounding and Bonding
- Fiber Routing
- Surface Raceway
- Labeling & Administration
- Cable Ties & Accessories